

G9 Drum Workstation



Producent

GEWA music GmbH
Oelsnitzer Straße 58
08626 Adorf

NIEMCY

Model	G9
Dokument	Instrukcja obsługi
Wersja	1.0
Data opracowania	2022-09-13



Proszę przeczytać instrukcję obsługi przed rozpoczęciem użytkowania a w szczególności część dotyczącą bezpieczeństwa. Proszę zachować ten dokument.



Kompletny dokument do ściągnięcia na
gewamusic.com:
<https://pl.gewamusic.com/downloads>

www.gewaelectronics.com

SPIS TRESCI

1	Informacje dotyczące bezpieczeństwa	1
1.1	Symbole używane w instrukcji	1
1.2	Procedury bezpieczeństwa	1
1.3	Przechowywanie	3
1.4	Niewłaściwe użytkowanie (przykłady)	3
1.5	Norma CE	4
1.6	Recycling	4
2	Części dostarczane z GEWA G9	5
3	Instrukcja złożenia	7

3.1	Montaż mocowania	7
3.2	Podłącz swoje wyposażenie do konsoli.....	7
3.2.1	Panel przedni	7
3.2.2	Panel tylni	8
3.2.3	Talerze.....	9
3.2.3.1	Talerze GEWA	9
3.2.3.2	Inni producenci.....	9
3.2.3.3	Analogowe talerze z osobnym kanałem do kopułki.....	10
4	Wyjaśnienie funkcjonowania fizycznych regulatorów	11
5	Włączenie urządzenia	12
6	Zanim zaczniesz...	13
6.1	Ustawienie triggerów	13
6.2	Bluetooth, Wi-Fi oraz Automatyczne wyłączenie.....	14
7	Interfejs użytkownika- podstaw	15
7.1	Tryb Łatwy.....	15
7.2	Wyłącz tryb łatwy.....	15
7.3	Praca z pokrętkami.....	16
7.4	Struktura Interfejsu	17
7.5	Ekran dotykowy	18
7.5.1	Klawiatura	18
8	Tryb występu (Performance)	21
8.1	Moduł 1	21
8.1.1	Drum Kit.....	21
8.1.1.1	Zarządzanie zestawami perkusyjnymi (Presety)	22
8.2	Moduł 2	23
8.2.1	Opcje zestawów (Kit Options).....	23
8.2.1.1	Detekcja Triggerów (Trigger Detection)	23
8.2.1.2	Detekcja przesterowania (Peak Detection).....	24
8.2.1.3	Style werbla (Snare Style) - Rimshot, Crosstick oraz X-Fade.....	25

8.2.2	Mikser (Mixer)	25
8.3	Moduł 3	25
8.3.1	Odtwarzanie utworów (Song Player)	25
8.3.1.1	Przeglądarka plików (File Select Browser)	26
8.3.1.1.1	Właściwości	26
8.3.1.1.2	Otwieranie Plików Audio.....	27
8.3.1.2	Funkcje odtwarzacza piosenek.....	28
8.3.1.2.1	Oś czasu	28
8.3.1.2.2	Tryb Odtwarzania.....	28
8.3.1.2.3	Tryb ddtwarzania z urządzeń zewnętrznych	29
8.3.1.2.4	Zapełnienie	29
8.3.1.2.5	Szybkie nagrywanie (Quick Record)	29
8.3.1.2.6	Zmiana tempa (Vari Speed)	30
8.3.1.2.7	Głośność utworów (Song Volume)	30
8.4	Moduł 4	30
8.4.1	Metronom (Metronome).....	30
8.4.2	Tryb wizyjny (Visual Mode).....	31
8.4.3	Ustawienia metronomu (Metronome Settings)	32
8.4.3.1	Dźwięk metronomu (Metronome Sound)	32
8.4.3.2	Tap Channel	32
9	Edytor zestawu (Kit Editor).....	35
9.1	Moduł 1	35
9.1.1	Channel Select.....	35
9.1.1.1	Input Channels	35
9.1.1.2	Auto Select	36
9.1.1.3	Peak Detection	36
9.2	Moduł 2	37
9.2.1	Instrument Select	37
9.2.1.1	Drum Kit.....	37
9.2.1.2	Pad Components.....	37
9.2.1.3	Sound Select	38
9.2.1.4	Sound Browser – Properties	38
9.2.1.4.1	Source – Internal.....	39

9.2.1.4.2	Source – Import	39
9.2.1.4.3	Assigning Sounds – Sound Grouping	39
9.2.1.5	Drum Kit Presets - Parameters	41
9.2.1.6	Preset Management - Elements	43
9.2.1.6.1	Loading Drum Kits.....	44
9.2.1.6.2	Saving and Overwriting Drum Kits.....	44
9.2.1.6.3	Rename Drum kits.....	45
9.2.1.6.4	Deleting Drum Kits	45
9.2.1.7	Drum Kit Exchange	45
9.2.1.7.1	Export	46
9.2.1.7.2	Import.....	46
9.2.2	Pad MIDI Settings	48
9.3	Moduł 3	49
9.3.1	Mix / Effect Sends	49
9.3.1.1	Volume (Component)	49
9.3.1.2	Panning (Input Channel)	49
9.3.1.3	Effects.....	49
9.3.2	Sound Edit	50
9.3.2.1	Tuning Coarse.....	50
9.3.2.2	Tuning Fine	50
9.3.2.3	Attack.....	51
9.3.2.4	Release	51
9.3.3	Second Sound Edit	52
9.3.3.1	Volume Second Sound	52
9.3.3.2	Tuning.....	52
9.3.3.3	Second Sound Select.....	52
9.3.3.4	Assignment of Second Sounds.....	53
9.3.4	Hi-Hat Volume Control	53
9.4	Moduł 4	54
9.4.1	Pad Equalizer / Compressor.....	54
10	Efekty (Effects).....	57
10.1	Effect Parameters.....	57
10.2	Effects Modules – Mutual Parameters.....	58

10.3	Effect Preset Parameters.....	59
10.4	Effects Presets.....	60
10.4.1	Loading Presets	61
10.4.2	Saving New Presets	61
10.4.3	Direct Storage of Parameter Values	61
10.4.4	Preset Overwrite	62
10.4.5	Renaming Presets.....	62
10.4.6	Deleting User Presets	62
10.5	Moduł 1	62
10.5.1	FX1 Ambience Samples.....	62
10.6	Moduł 2.....	63
10.6.1	FX 2 Instrument Reverb	63
10.6.1.1	Reverb Types and Parameters	63
10.7	Moduł 3.....	65
10.7.1	FX3 Room Reverb	65
10.8	Moduł 4.....	65
10.8.1	FX 4 Multi Effects.....	65
11	Ustawienia triggerów (Trigger Settings).....	71
11.1	Moduł 1	71
11.1.1	Trigger Detection.....	71
11.1.1.1	Input Channels	72
11.1.1.2	Auto Select.....	73
11.1.1.3	Peak Detection	73
11.2	Moduł 2.....	73
11.2.1	Trigger Selection	73
11.2.1.1	Setup	73
11.2.1.1.1	Standard Setups.....	74
11.2.1.2	Trigger Bank.....	75
11.2.1.3	Presets - Setup and Trigger Bank.....	75
11.2.1.3.1	Loading Presets	77
11.2.1.3.2	Saving New Presets.....	78
11.2.1.3.3	Direct Storage of Parameter Values - Setups	78

11.2.1.3.4	Overwrite Presets	79
11.2.1.3.5	Renaming Presets.....	79
11.2.1.3.6	Deleting User Presets	79
11.2.1.4	Pad Components.....	79
11.3	Moduł 3	80
11.3.1	Trigger Settings.....	81
11.3.1.1	Gain	82
11.3.1.2	Threshold.....	83
11.3.1.3	High level.....	84
11.3.1.4	Scan time.....	84
11.3.1.5	Retrigger Mask	84
11.3.1.6	X-Talk	85
11.3.1.6.1	Adjusting X-Talk Parameters.....	85
11.3.1.7	High Position (Hi-Hat Pedal only)	85
11.3.1.8	Low Position (Hi-Hat Pedal only)	85
11.3.1.9	Chick Sensitivity (Hi-Hat Pedal only)	86
11.3.1.10	Kalibracja pedału (Hi-Hat)	86
11.3.2	Advanced Settings	88
11.3.2.1	Dyn Level & Dyn Time	88
11.3.2.2	Splash Sensitivity (Hi-Hat Pedal only)	88
11.3.2.3	Typów trigerów (Trigger Type)	88
11.3.2.4	Curve Settings.....	89
11.3.2.4.1	Assigning Preset Curves	89
11.3.2.5	Curve Editor	92
11.3.2.5.1	Creating Custom Curves	92
11.4	Moduł 4	94
11.4.1	Trigger Monitor.....	94
11.4.1.1	Pad Monitor	95
11.4.1.2	X-Talk Monitor	95
12	Ogólne ustawienia (General Settings)	97
12.1	Moduł 1	97
12.1.1	Master Outs	98
12.1.2	Direct Outs	98
12.1.3	Digital In/Out	99

12.1.4	Routing Drums & Routing Others	99
12.1.4.1	Editing the Routing Matrix	101
12.1.4.2	Presets – Routing	102
12.1.4.2.1	Loading Presets	103
12.1.4.2.2	Saving New Presets.....	103
12.1.4.2.3	Overwrite Presets.....	104
12.1.4.2.4	Renaming Presets.....	104
12.1.4.2.5	Deleting User Presets.....	104
12.2	Moduł 2	104
12.2.1	Master Channel Headphone Monitor Outs	104
12.2.1.1	Equalizer	105
12.2.1.1.1	Parameters and Description.....	105
12.2.1.1.2	Editing EQ Curves.....	106
12.2.1.2	Compressor	107
12.2.1.2.1	Parameters and Description.....	108
12.2.1.2.2	Editing Compressor Curves	108
12.2.1.3	Presets – Equalizer and Compressor	109
12.2.1.3.1	Loading Presets	110
12.2.1.3.2	Saving New Presets.....	111
12.2.1.3.3	Overwrite Presets.....	111
12.2.1.3.4	Renaming Presets.....	111
12.2.1.3.5	Deleting User Presets.....	112
12.2.2	Control	112
12.3	Moduł 3	113
12.3.1	MIDI	113
12.3.1.1	Global MIDI Settings (Soft Thru)	113
12.3.1.1.1	Routing MIDI Signals.....	114
12.3.1.1.2	Local Control.....	115
12.3.1.1.3	MIDI Channel.....	115
12.3.1.1.4	MIDI Control.....	115
12.3.2	Drumkit Program Change.....	116
12.3.2.1	Program Pairing	117
12.3.2.2	Channels (Transmit/Receive).....	117

12.4	Moduł 4	118
12.4.1	Device.....	118
12.4.1.1	Auto Off	118
12.4.1.2	Knob Brightness	118
12.4.1.3	Start Screen	119
12.4.1.4	UI Theme.....	119
12.4.2	Wi-Fi	119
12.4.3	Bluetooth.....	120
12.4.3.1	Custom Bluetooth Names	120
12.4.4	Fabryczny reset (Factory Reset)	121
12.4.5	Information	122
12.4.6	Update	122
12.4.6.1	Download/Pobieranie – Firmware, Instrukcja	122
12.4.6.1.1	Downloads/Pobieranie z gewamusic.com	122
12.4.6.1.2	Pobieranie bezpośrednie z urządzenia	123
12.4.6.2	Aktualizuj urządzenie	124
12.4.6.2.1	Aktualizacja oprogramowania przez usb.....	124
12.4.6.2.2	Aktualizuj procedurę za pomocą modułu	125
13	Narzędzi (Tools)	127
13.1	On Stage	127
13.1.1	Tiles – Assignable Media Types	128
13.1.2	Editing Tiles – Assign Expressions for Media Types.....	128
13.1.3	Setlist Presets	129
13.1.3.1	Loading Setlists	130
13.1.3.2	New Setlists.....	131
13.1.3.3	Save Setlists.....	131
13.1.3.4	Rename Setlists	131
13.1.3.5	Delete Setlists	132
13.1.4	Working with Setlists	132
13.1.4.1	Pdf Viewer	132
13.2	Czytnik PDF (PDF Reader)	134
13.2.1	Przeglądarka plików (File Select Browser).....	135
13.2.1.1	Właściwości.....	135
13.2.1.2	Otwieranie Plików PDF	136

13.2.2	Bookmarks and Thumbnails	136
13.3	Menedżer plików (File Manager).....	137
13.3.1	Menedżer plików vs. Importowanie próbek dźwięku	138
13.3.2	Screen Layout and General Properties.....	138
13.3.3	Task Bar	139
13.3.4	Collections – Concept and Overview	140
13.3.5	Compiling Collections.....	142
13.3.6	Selection Rules and Methods.....	142
13.3.6.1	Parenting	142
13.3.6.2	Membership of a Collection.....	142
13.3.6.3	Refresh vs. Uncheck All	143
13.3.7	Collection Based Tasks -Move/Copy/Delete.....	143
13.3.8	Organize – New Folder and Rename	144
13.3.8.1	New Folder.....	144
13.3.8.2	Rename.....	144
13.3.9	History – Undo and Redo	144
13.3.10	Closing the App.....	145
13.4	Utilities	145
13.4.1	Wyszukiwania (Search).....	145
13.4.1.1	Properties	145
13.4.1.2	Conception	146
13.4.2	Filter Manager	147
13.4.2.1	Properties	148
13.4.2.2	Filters and Sorting Options.....	148
13.5	Importowanie próbek dźwięku (Import Tool).....	149
13.5.1	Importerze (Importer)	150
13.5.2	Import Custom Samples (Single Layer)	151
13.5.3	Import Sounds from the Cloud.....	152
13.5.4	Delete Sounds from the Library	153
13.5.5	Limity importu i zarządzanie dźwiękiem.....	153
13.5.5.1	Fakty.....	153
13.5.5.2	Scenariusze ograniczeń importu.....	154
13.5.5.3	Reagowanie na limity importu	154
13.5.5.4	Utrata danych.....	154
13.6	Sklep (Shop).....	155

13.6.1	Connecting to the Cloud.....	155
13.6.2	Billing Process.....	158
13.6.3	Digital Property Rights.....	158
13.6.4	Sale or exchange of a G9 device.....	158
14	Useful Information	159
14.1	Explanation of Terms	159
14.2	Gwarancja	160
15	Problemy i możliwe ich rozwiązania	161
16	Dane techniczne.....	162

Drogi użytkowniku,

Dziękujemy za zakup naszego modułu GEWA G9!

Wybrałeś najwyższej jakości cyfrową konsolę perkusyjną, która zapewnia imponujący dźwięk i wrażenia z gry, dzięki ogromnej bazie brzmień, łatwości w użyciu i dostępu do wielu ciekawych funkcji.

Twoje bezpieczeństwo jest dla nas bardzo ważne! Proszę więc uważnie przeczytać informacje dotyczące bezpieczeństwa i zastosować się do zaleceń.

Zalecamy przechowywanie tej instrukcji obsługi w bezpiecznym i dostępnym miejscu dla bezpiecznego użytkownika modułu G9 Drum.

1 INFORMACJE DOTYCZĄCE BEZPIECZEŃSTWA

Producent nie ponosi odpowiedzialności za obrażenia osób lub szkody materialne wynikające z niewłaściwego użytkownika urządzenia!

Używaj wyłącznie cyfrowego zestawu perkusyjnego zgodnie z poniższą instrukcją.

1.1 SYMBOLE UŻYWANE W INSTRUKCJI

Poniższe symbole służą do sygnalizowania zagrożeń i udzielania porad:

Poziom ryzyka	Symbol		Definicja
Poważne obrażenia		OSTRZEŻENIA	Nieprzestrzeganie poniższych instrukcji bezpieczeństwa może spowodować poważne obrażenia lub śmierć.
Zagrożenie porażeniem elektrycznym		OSTRZEŻENIE	Nieprzestrzeganie poniższych instrukcji bezpieczeństwa może spowodować poważne obrażenia lub śmierć z powodu porażenia prądem.
Drobne obrażenia i uszkodzenie urządzenia		UWAGA	Nieprzestrzeganie poniższych instrukcji bezpieczeństwa może spowodować niewielkie obrażenia i / lub uszkodzenie urządzenia
Uwagi		UWAGA	Pomaga uniknąć obrażeń oraz uszkodzenia urządzenia
Wskazówka		WSKAZÓWKA	Wskazówki dotyczące optymalnej obsługi cyfrowej konsoli perkusyjnej GEWA

1.2 PROCEDURY BEZPIECZEŃSTWA

Zawsze przestrzegaj podanych tutaj środków bezpieczeństwa. Nieprzestrzeganie zasad bezpieczeństwa może mieć poważne konsekwencje:

- Poważne obrażenia, a nawet śmiertelne wypadki
- Zagrożenie porażeniem elektrycznym
- Zwarcia
- Obrażenia
- Ogień

Możliwe są dalsze lub inne zagrożenia; dlatego lista ta nie jest kompletna.



OSTRZEŻENIA PORAŻENIE PRĄDEM



- Nie narażaj urządzenia na kontakt z wodą – zalanie, zachlapanie itp.
- Nigdy nie umieszczaj pojemników wypełnionych wodą lub płynami (wazonów, szklanek itp.) na konsoli lub w jej pobliżu.
- Wtyczka sieciowa powinna być łatwo dostępna. Nigdy nie używaj uszkodzonych zasilaczy / przewodów.
- Zainstaluj firmowe zasilacze / kable, aby uniknąć ryzyka uszkodzenia.
- Nawet niskie napięcie elektryczne może prowadzić do poważnych obrażeń, a nawet śmierci!
- Nigdy nie otwieraj konsoli.
- Nigdy nie wkładaj wody ani płynów do konsoli bębna.
- Nigdy nie czyść cyfrowej konsoli bębna wilgotną szmatką.
- Nigdy nie podłączaj ani nie odłączaj konsoli mokrymi rękami i nigdy nie ciągnij za kabel, ponieważ może być uszkodzony.
- Jeśli ciecze lub woda przypadkowo dostaną się do konsoli, natychmiast odłącz ją od zasilania. We wszystkich powyższych przypadkach sprawdzisz cyfrową konsolę w autoryzowanych punktach obsługi klienta GEWA.
- Nigdy nie używaj uszkodzonych zasilaczy / kabli.
- Mocno zainstaluj zasilacze / kable, aby uniknąć ryzyka uszkodzenia.
- Chroń przewód zasilający przed uszkodzeniem lub przerwaniem, szczególnie przy wtyczkach oraz gniazdach, w którym wychodzą kable do urządzenia.



OSTRZEŻENIA Zapobieganie pożarom

- Zapewnij minimalną odległość 7 cm (3 cale) wokół urządzenia, aby zapewnić odpowiednią wentylację.
- Upewnij się, że wentylacja nie jest utrudniona przez zakrycie otworów wentylacyjnych takimi przedmiotami jak gazety, obrusy, zastony itp.
- Nie stawiaj na urządzeniu źródeł otwartego ognia, takich jak zapalone świece. Świece lub lampy naftowe mogą się przewrócić i spowodować pożar.
- Nigdy nie należy rozpalać ognia na lub w pobliżu cyfrowego zestawu perkusyjnego.
- Nie instaluj w pobliżu źródeł ciepła, takich jak kaloryfery, rejestratory ciepła, piece lub inne urządzenia (w tym wzmacniacze) wytwarzające ciepło.
- Używaj urządzenia tylko w umiarkowanym klimacie (nie w klimacie tropikalnym).



OSTRZEŻENIA

W przypadku nieoczekiwanego i nietypowego zachowania konsoli



- Wyłącz konsolę lub odłącz ją natychmiast od zasilania, jeśli nastąpi:
 - nagła utrata dźwięku, gdy konsola jest używana
 - konsola emituje niezwykły zapach lub dym.
- Niezbędne jest sprawdzenie konsoli bębna przez dział obsługi klienta GEWA.



UWAGA

Uszkodzenie

- Niedopasowanie napięcia elektrycznego może uszkodzić konsolę. Obsługuj cyfrową podporę bębna tylko w prawidłowym zakresie napięcia (zaznaczonym na odpowiedniej płytce specyfikacji).
- Używaj wyłącznie zasilacza i kabla zasilającego dostarczonego z urządzeniem.
- Nigdy nie należy umieszczać kabla zasilającego w pobliżu źródeł ciepła, takich jak kaloryfery lub promienniki.
- Nie zginaj gwałtownie kabla ani nie uszkadzaj go w inny sposób (! Niebezpieczeństwo zerwania kabla!).
- Ułóż kabel zasilający w taki sposób, aby uniknąć potknięcia się lub przewrócenia ciężkiego przedmiotu.
- Nie umieszczaj żadnych przedmiotów na kablu zasilającym.

- Regularnie sprawdzaj zasilanie i usuń widoczny kurz lub brud z urządzenia.

**UWAGA****Uszkodzenia spowodowane burzami**

- Burze z piorunami mogą powodować przebiecia elektryczne, które mogą uszkodzić konsolę bębna.
- Podczas burzy z piorunami, zalecamy całkowite odłączenie konsoli od układu elektrycznego.
- Jeżeli konsola nie jest używana przez dłuższy czas to zalecamy całkowite odłączenie konsoli od układu elektrycznego.

1.3 PRZECHOWYWANIE

- Przechowuj cyfrową konsolę bębna w suchym środowisku.
- Można podłączyć akcesoria audio do odtwarzania dźwięku (podłączonego do wejścia lub wyjścia konsoli) lub do transmisji danych. Akcesoria muszą odpowiadać odpowiednim specyfikacjom technicznym (w związku z tym patrz rozdział 16, Dane techniczne).
- Tylko i zawsze korzystaj z zasilaczy certyfikowanych przez GEWA i upewnij się, że są prawidłowo podłączone. Zastosowany zasilacz musi również spełniać specyfikację napięcia w danym kraju (tabliczka znamionowa na adapterze).
- Cyfrowy zestaw perkusyjny może być używany tylko w oryginalnym stanie. Wszelkie modyfikacje zestawu bębna są niedozwolone i skutkują całkowitą utratą gwarancji.
- Cyfrowy zestaw perkusyjny musi być ustawiony na bezpiecznym, stabilnym, równym podłożu lub platformie, która jest w stanie utrzymać ciężar (patrz rozdział 16, Dane techniczne).

1.4 NIEWŁAŚCIWE UŻYTKOWANIE (PRZYKŁADY)

- Narażenie cyfrowej konsoli perkusyjnej na otwarte powietrze lub wilgotne / deszczowe środowisko.
- Ustawianie cyfrowego zestawu perkusyjnego w wilgotnych pomieszczeniach.
- Używanie zasilaczy nieautoryzowanych przez muzykę GEWA lub podłączanie konsoli do gniazdka elektrycznego pomimo niezgodności lokalnych specyfikacji napięcia.
- Odtwarzanie cyfrowego zestawu perkusyjnego w pobliżu urządzeń elektrycznych lub elektronicznych, takich jak systemy stereo, telewizory, radia lub telefony komórkowe. Urządzenia te mogą powodować zakłócenia i poważnie wpływać na jakość dźwięku cyfrowego zestawu perkusyjnego GEWA.
- Używanie długich przewodów audio może również zakłócać jakość dźwięku.
- Należy zdecydowanie unikać transportu i konfiguracji w połączeniu z silnymi wibracjami i wstrząsami, pyłem i ekspozycją na ciepło (np. w pojazdach lub bezpośrednim świetle słonecznym lub obu).
- Granie na wyświetlaczu pałkami lub innymi przedmiotami może uszkodzić szkło ochronne. Używaj tylko palców oraz zapewnij wystarczającą odległość pomiędzy modulem a podłączonym sprzętem, aby fizyczny kontakt pałki nie był możliwy.



Producent nie ponosi odpowiedzialności w przypadku szkód powstałych w następujących przypadkach:

- **Niezgodność z instrukcjami bezpieczeństwa**
- **Niewłaściwa obsługa**

- **Łączenie niekompatybilnych urządzeń / urządzeń wyjściowych itp. Lub innych urządzeń interfejsu innych producentów.**

1.5 NORMA CE



Twoja konsola bębna GEWA G9 jest zgodna z wymaganiami dyrektyw UE:

Dyrektywa 2014/53/EU

Normy, do których deklarowana jest zgodność:

EN55020:2007+A11:2011

EN55024:2010

EN55032:2012

EN61000-3-2:2014

EN61000-3-3:2013

EN301489-17:V3.2.0

EN60065:2014

EN62311:2008

2009/125/EC: 2009 (EC Regulation 1275/2008 + 801/2013)

EN300328:V2.1.1

EN301893:V2.1.1

Zgodność z powyższymi dyrektywami potwierdza oznakowanie CE na urządzeniu. Deklarację zgodności można obejrzeć pod następującym adresem:

GEWA music GmbH
Oelsnitzer Straße 58
08626 Adorf
GERMANY

1.6 RECYCLING



W przypadku konieczności utylizacji cyfrowej konsoli należy przekazać ją do lokalnego punktu zarządzania odpadami w lokalnej społeczności (np. Firmy zajmujące się utylizacją, centra recyklingu).

Wyświetlany symbol wymaga, aby urządzenia oznaczone tym symbolem były usuwane oddzielnie od odpadów domowych. Zgodnie z ustawą o sprzęcie elektrycznym i elektronicznym właściciele urządzeń oznaczonych tym symbolem są zobowiązani przez prawo federalne do deponowania zużytego sprzętu elektrycznego i elektronicznego w osobnej selekcji odpadów.

Pomóż nam swoim wkładem w ochronę środowiska, nie usuwając starego sprzętu elektrycznego do nieselekcjonowanych odpadów domowych.

2 CZĘŚCI DOSTARCZANE Z GEWA G9

Oryginalne opakowanie zawiera następujące elementy. Sprawdź dokładnie kompletność zakupionego produktu:

<p>G9 Drum Workstation</p>  <p>1x</p>	<p>10,5-12,7 mm Uchwyt montażowy</p>  <p>1x</p>	<p>Karta produktu</p>  <p>1x</p>
<p>USB Pendrive</p>  <p>1x</p>	<p>Instrukcja Quick Start/Szybki start (wielojęzyczna)</p>  <p>1x</p> <p>Kabel zasilający 2 m (IEC C18)</p>	
<p>Typ C (CEE 7/17) (EU CU IL IN)</p>  <p>1x</p>	<p>Typ A (US CA CU JP TW)</p>  <p>1x</p>	<p>Typ G (UK)</p>  <p>1x</p>
<p>Typ I (AU AR NZ)</p>  <p>1x</p>	<p>Typ C (CEE 7/16) (CH)*</p>  <p>1x</p>	

*Only for use in Switzerland! | Nur zur Verwendung in der Schweiz! | Pouze pro použití ve Švýcarsku! | Solamente para el uso en Suiza! | Seulement pour l'usage en Suisse! | Solo per l'uso in Svizzera! | Tylko do użytku w Szwajcarii! | Apenas para uso na Suíça!

3 INSTRUKCJA ZŁOZENIA

3.1 MONTAŻ MOCOWANIA

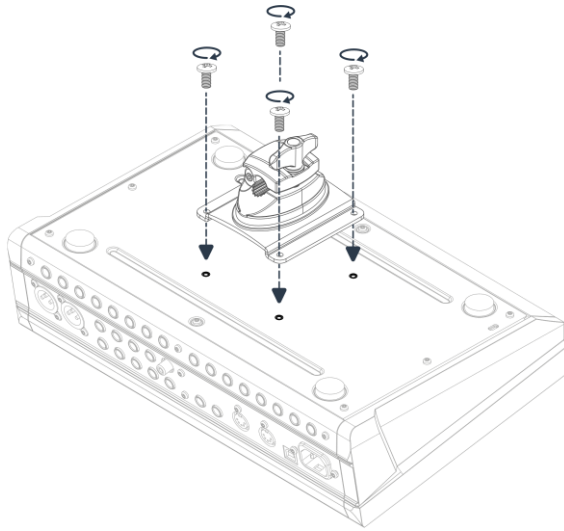

3.2 PODŁĄCZ SWOJE WYPOSAŻENIE DO KONSOLI

3.2.1 PANEL PRZEDNI

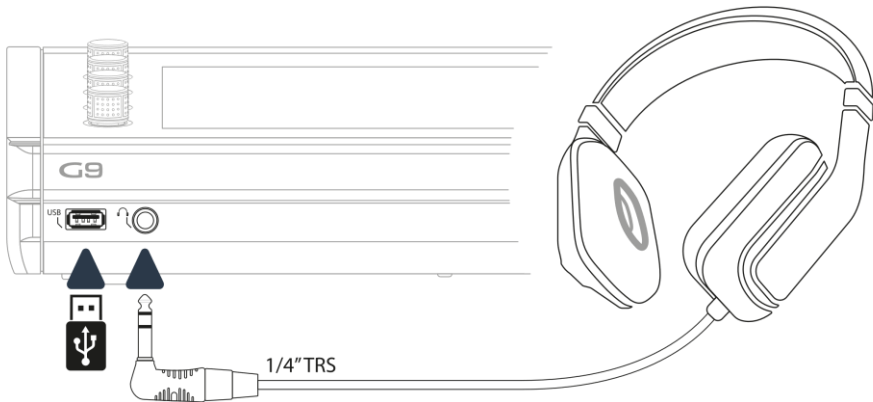

3.2.2 PANEL TYLNI

Upewnij się, że zasilanie jest wyłączone podczas podłączania modułu do urządzeń zewnętrznych.

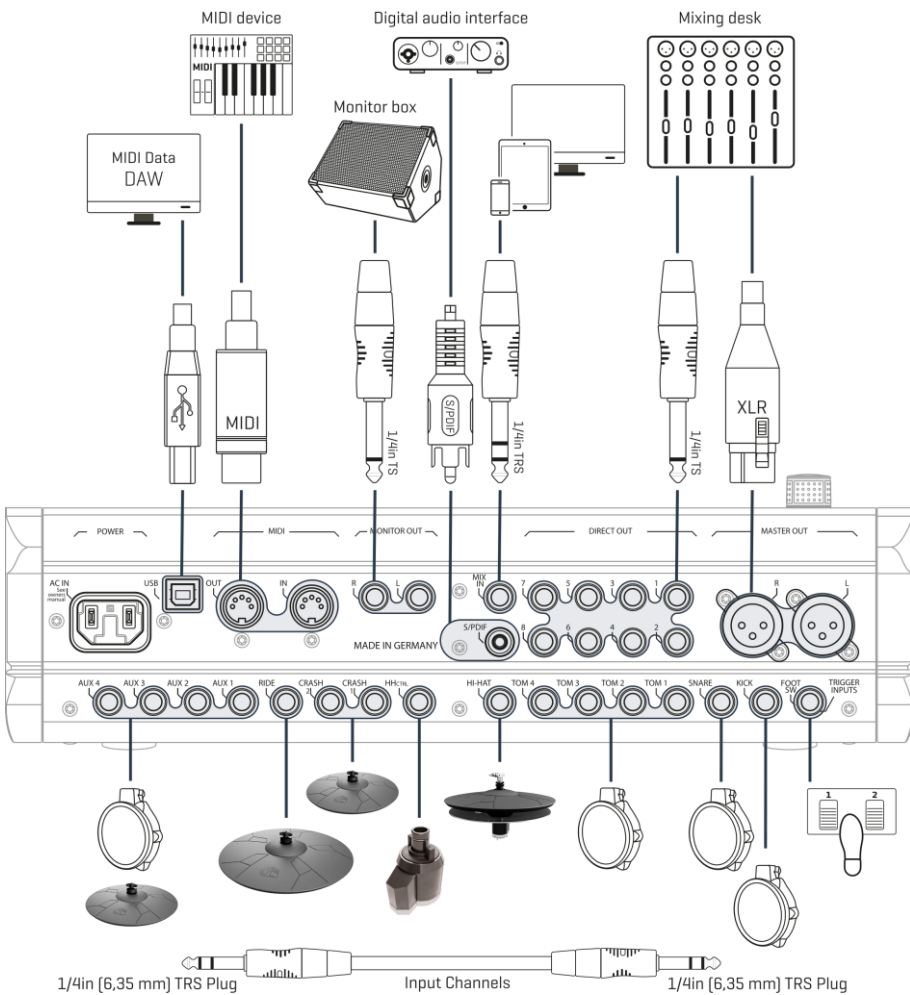

3.2.3 TALERZE

3.2.3.1 TALERZE GEWA

Talerze GEWA są wyposażone w dwa gniazda stereo (standard TRS 6,35 mm - 1/4"). W połączeniu z modułami GEWA istotne jest tylko gniazdo najbliższej środkowego otworu talerza.

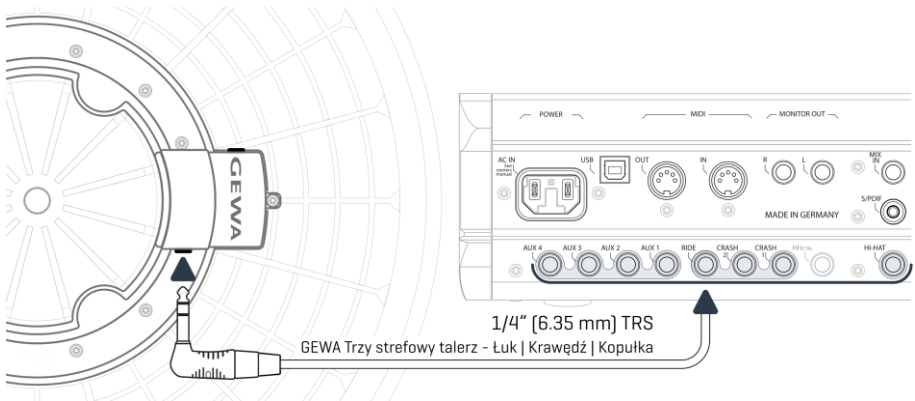

3.2.3.2 INNI PRODUCENCI

Jeśli chodzi o blachy analogowe innych producentów, użyj odpowiednich gniazd wejściowych w następujący sposób:

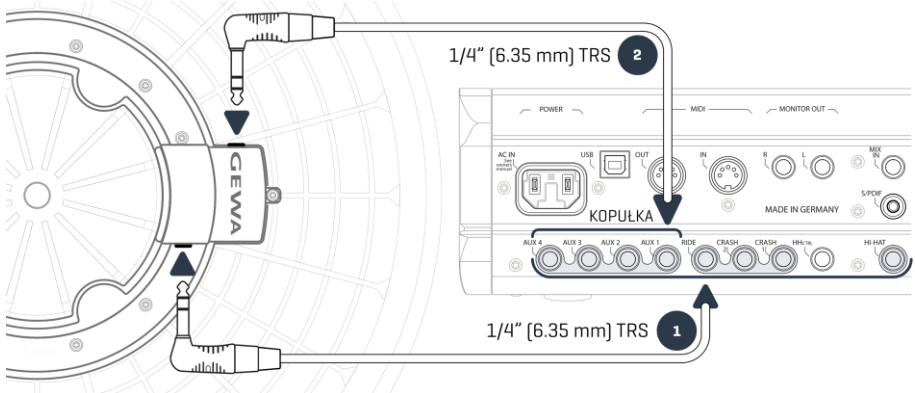

Podłączenie innych talerzy



Rodzaj talerza	Komponenty	Komponenty	Rodzaj Triggerów (Ustawienia Triggerów)
	1	2	Trigger Type
Jedno strefowy talerz	Krawędź	Nie używany	Single/Dual
Dwu strefowy talerz	Łuk Krawędź	Nie używany	Dual
Trzy strefowy talerz bez dodatkowego wyjścia na kopułkę	Łuk Krawędź Kopułka	Nie używany	Dual
Trzy strefowy talerz z dodatkowym wyjściem na kopułkę	Łuk Krawędź	Kopułka	3Way
 Wskazówka	Różne rodzaje talerzy będą działać tylko w połączeniu z odpowiednim rodzajem triggera. Więcej informacji na temat typów triggerów znajduje się w sekcji 11.3.2.3 Typów triggerów (Trigger Type) na str 88.		

3.2.3.3 ANALOGOWE TALERZE Z OSOBNYM KANAŁEM DO KOPUŁKI

Talerze z dodatkowym wyjściem na kopułkę (Bell) można łączyć się z konsolami GEWA na różne sposoby. Zobacz poniższą tabelę dla wszystkich możliwych kombinacji kanałów dla Łuku / Krawędzi i kopułki:

GEWA –wejścia dla analogowych talerzy z osobnym kanałem dla kopułki		
	Talerz	
	Łuk/Krawędź	Kopułka
Wejście (Input Channel)	Ride	Aux 1
	Aux 1	Aux 2
	Aux 2	Aux 3
	Aux 3	Aux 4
 Wskazówka	Talerze z kanałem dla kopułki wymagają ustawienia Triggerów Typ 3Way dla kanałów ŁUK / Krawędź (komponent Łuk). Więcej informacji na temat typów triggerów znajduje się w sekcji 11.3.2.3 Typów triggerów (Trigger Type) na str 88.	

Wszystkie pozostałe pady analogowe łączy się wg. wskazań na tylnym panelu.

4 WYJAŚNIENIE FUNKCJONOWANIA FIZYCZNYCH REGULATORÓW

Funkcjonalność fizycznych pokręteł i przycisków może się różnić w zależności od interfejsu użytkownika (oprogramowania). Niektóre przyciski można dostosować. Ta sekcja opisuje standardowe funkcje podczas uruchamiania urządzenia.

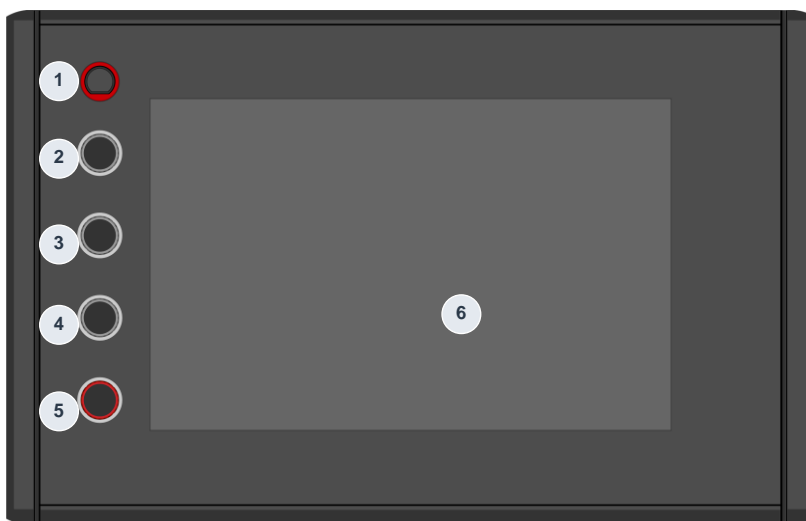

Panel & Ekran – Standardowe funkcje

●	Włącznik/wyłącznik
	Włączenie i wyłączenie urządzenia
●	Pokrętko
	Tempo metronom
3	Pokrętko
	Głośność monitorowa / Sumy
4	Pokrętko
	Głośność słuchawek
●	Pokrętko/Przycisk
	Suma głośności (Master XLR)
	Naciśnij, aby powrócić do ekranu głównego
●	Ekran dotykowy
	Różne gesty i funkcje

5 WŁĄCZENIE URZĄDZENIA

- 1 Podłącz wtyczkę prądu stałego zasilacza sieciowego do gniazda DC IN na tylnym panelu.
- 2 Podłącz wtyczkę do gniazda prądowego.

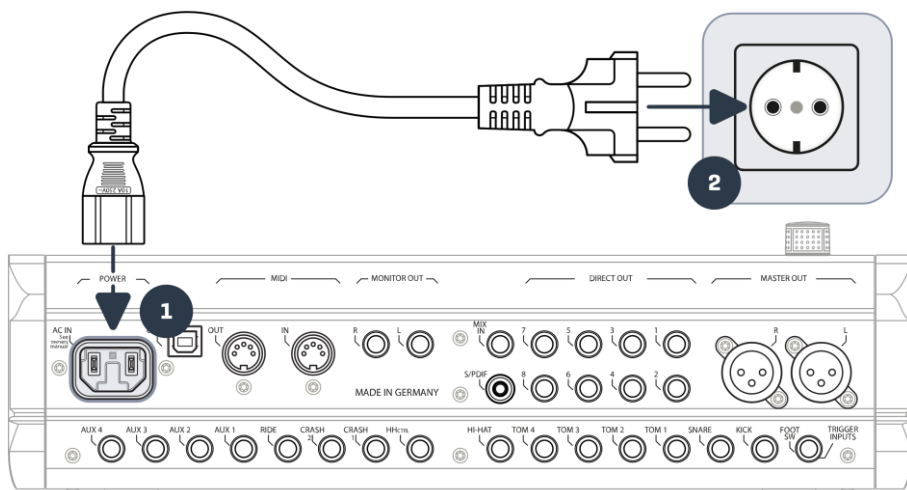

- 3 Przy prawidłowo podłączonym przewodzie **[Przycisk zasilania]** świeci się na czerwono. Urządzenie jest w trybie gotowości i jest gotowe do eksploracji. Naciśnij **[Przycisk zasilania]**, aby uruchomić urządzenie.
- 4 Poczekaj aż uruchomi się oprogramowanie.

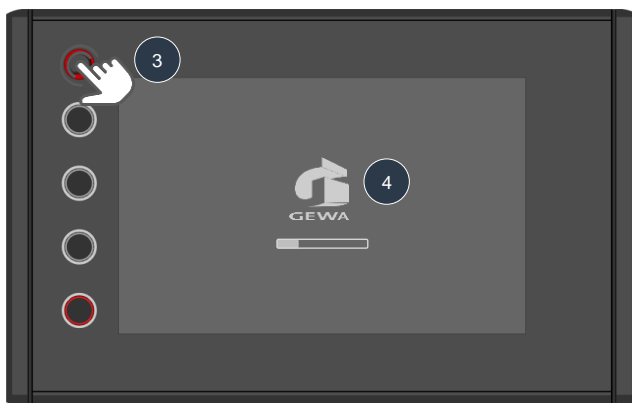

Uwaga: Aby oszczędzać energię, G9 zapewnia funkcję „Auto Power”. Dzięki tej funkcji stacja robocza wyłączy się automatycznie, pozostawiając ją bezczynną przez ponad 30 minut. Zmień tę właściwość w **General Settings** → **Moduł 4** → **Device** → **Auto Off**

6 ZANIM ZACZNIESZ...

Ta część zawiera krótkie wprowadzenie do najważniejszych głównych ustawień stacji roboczej G9.

6.1 USTAWIENIE TRIGERÓW

Konsola bębna GEWA zapewnia wstępne ustawienia dla różnych dostępnych konfiguracji padów. Jeśli zakupisz jeden z kompletnych zestawów G9, to wybierz jedną z poniższych konfiguracji, aby przywołać optymalne ustawienia:

GEWA Studio | GEWA PRO 5 | GEWA PRO 6

Postępuj zgodnie z instrukcjami bezpieczeństwa zawartymi w sekcjach 1-5 podręcznika Szybki start / Podręcznik użytkownika i wykonaj następujące czynności:

1



Naciśnij
włącznik





Start G9

2



Dotknij ikonę







3



Dotknij
Trigger
Settings





4

Dotknij Setup

2 x



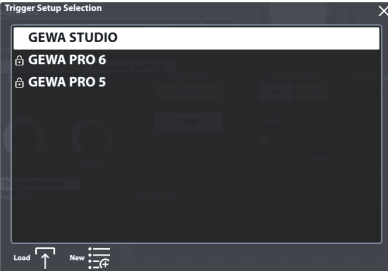

6.2 BLUETOOTH, WI-FI ORAZ AUTOMATYCZNE WYŁĄCZENIE

Uzyskaj dostęp do opcji bezprzewodowych i wyłącz zegar w **Ustawieniach ogólnych (General Settings)**.

Hasło Bluetooth: 4392

1



Naciśnij włącznik

Start G9

2



Dotknij ikonę Advanced



3



General Settings

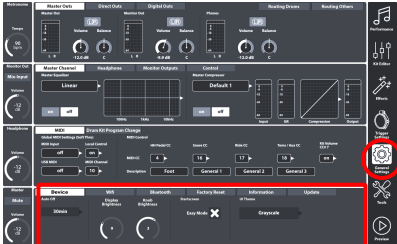

Bluetooth

Device	Wi-Fi	Bluetooth	Factory Reset	Information	Update
Bluetooth <input checked="" type="checkbox"/> on <input type="checkbox"/> off set Bluetooth visible → The Device will be visible for 2 minutes. GEWA G9				Hasło Bluetooth 4392	

Wi-Fi

Device	Wi-Fi	Bluetooth	Factory Reset	Information	Update
Wifi <input checked="" type="checkbox"/> on <input type="checkbox"/> off Search →		Network: n/a		IP-Address: n/a Subnet Mask: n/a Router: n/a DNS: n/a	

Automatyczne wyłączenie (Auto Off)

Device	Wi-Fi	Bluetooth	Factory Reset	Information	Update
Auto Off 30min	Display Brightness 9	Knob Brightness 3	Startscreen Easy Mode ✕	UI Theme Grayscale	

7 INTERFEJS UŻYTKOWNIKA- PODSTAW

This section covers general aspects of using the G9 Drum Workstation. You will learn how to work with physical and digital **Dials**, learn about the **Interface Structure** and gain a fundamental understanding of using the built in **Touch Screen**. Please choose a topic from the submenu in this section.

7.1 TRYB ŁATWY

Domyślnie G9 uruchamia się na ekranie graficznym z najbardziej podstawowymi funkcjami, takimi jak:

- Wybór gotowych zestawów perkusyjnych (dotknij Nazwa zestawu lub **[+]** i **[-]**)
- Stuknij w Bębny i talerze, aby usłyszeć dźwięk
- Podstawowe funkcje metronomu (włączanie, wyłączenie i wybieranie tempa)
- Mikser głośności padów
- Pokręta głośności wyjścia (Master, Headphone, Monitor Out i Mix-Input)



Wszystkie te funkcje można jeszcze bardziej ulepszyć/zmienić w trybach zaawansowanych, które są dostępne po dotknięciu **[Przycisk zaawansowany]** w prawym dolnym rogu. Wszystkie zmiany wprowadzone w trybach zaawansowanych od razu zaczną działać w trybie łatwym. Wróć do łatwego trybu, naciskając przycisk **[Home]** (czerwone pokrętko).

7.2 WYŁĄCZ TRYB ŁATWY

W razie potrzeby można zastąpić **tryb łatwy trybem wyołpku (Performance)**

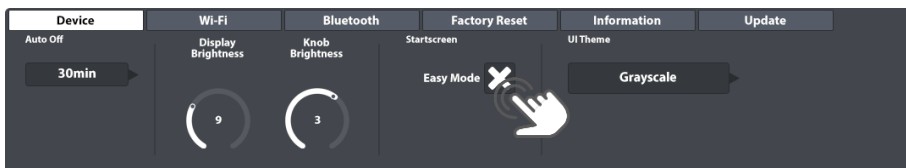

Aby uruchomić postępuj wg. Wskazań poniżej:

1. Dotknij ikonę **[Advanced Button/przycisk zaawansowany]**.
2. Idź do: **General Settings → Moduł 4 → Device → Start Screen**
3. Odnznacz „Easy Mode”

i Wskazówka: Odznaczenie „Łatwy tryb” wpłynie na ekran startowy, a także na funkcjonalność przycisku **[Dom]**.

7.3 PRACA Z POKRĘTŁAMI



Aby rozpocząć, naciśnij raz **[Red Dial]**, aby przejść do ekranu Easy Mode. Oprócz ekranu dotykowego dodaliśmy fizyczne pokręta dla kluczowych funkcji, które znajdują się po lewej stronie ekranu. Czerwone pokrętło na dole kontroluje głośność główną (master out) i służy jako **przycisk home**. Bez względu na wszystko - naciśnięcie czerwonego pokrętła spowoduje powrót do łatwego trybu. Po dotknięciu przycisku **Master** obok czerwonego pokrętła pojawi się pasek głośności, który można dostosować, przeciągając palcem w górę lub w dół. Dwukrotne stuknięcie paska spowoduje przejście suwaka do domyślnej wartości fabrycznej. Gdy jesteś zadowolony z ustawienia głośności głównej, możesz ponownie dotknąć **[Master]**, aby zamknąć pasek głośności. Poruszając się w górę, następane pokrętło steruje głośnością **sluchawek (Headphone)**, trzecie pokrętło reguluje głośność **wejścia miksu (Mix-Input)**, a najwyższe pokrętło kontroluje prędkość **metronomu**.



Należy pamiętać, że w trybie **Ustawienia triggerów (Trigger Settings)** szare pokrętki zmieniają funkcję na inne jak np. **czułość**, ale pokrętło **główne czerwone** nadal działają w taki sam sposób, jak przedstawiono na przykładzie głośności **głównej (Master XLR)**.

7.4 STRUKTURA INTERFEJSU

G9 jest podzielony na kilka sekcji zwanych **trybami**. Domyślnie konsola uruchamia się w **łatwym trybie**. Możesz przejść do trybów zaawansowanych jednym dotknięciem przycisku **[Zaawansowane]** w prawym dolnym rogu. Ikony trybów zaawansowanych znajdują się na pasku bocznym po prawej stronie ekranu. Interfejs G9 obejmuje łącznie 6 zaawansowanych trybów:

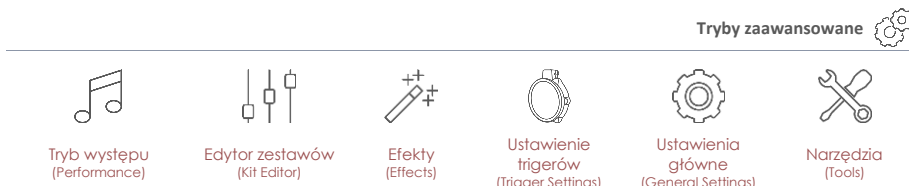

W trybie wszystkie funkcje są podzielone na moduły tematyczne. **Moduły** są dalej podzielone na **zestawy funkcji**. Aktywne zestawy funkcji są wyróżnione w kolorach motywu interfejsu użytkownika. Zatem hierarchia menu G9 ma następującą strukturę:

Tryb → Moduł → Zestawy funkcji → Funkcje



Zobacz tę strukturę zaimplementowaną w układzie ekranu G9:

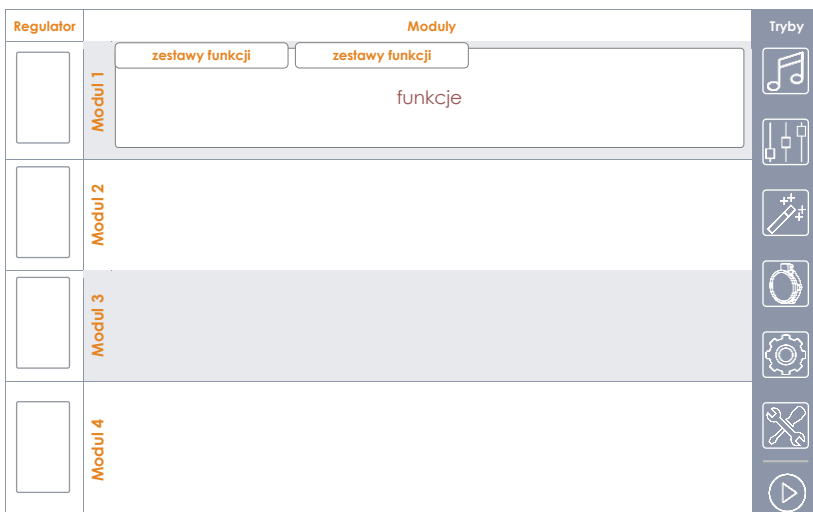

7.5 EKRAŃ DOTYKOWY

Wiele opcji można wybrać za pomocą intuicyjnego ekranu dotykowego, takiego jak przeciąganie palcem, rozwijanie klawiatury numerycznej i wybór, do których można uzyskać dostęp, dotykając raz. **Pola** z rozwijanymi menu mają małą **flagę** (▶) dołączoną po prawej stronie ramek. Gdy są widoczne, przyciski **[+]** i **[-]** pozwalają na poruszanie się po menu głównym (Jeden wpis na stuknięcie).

Krzyż w prawym górnym rogu służy jako alternatywa dla zamykania dialogów.

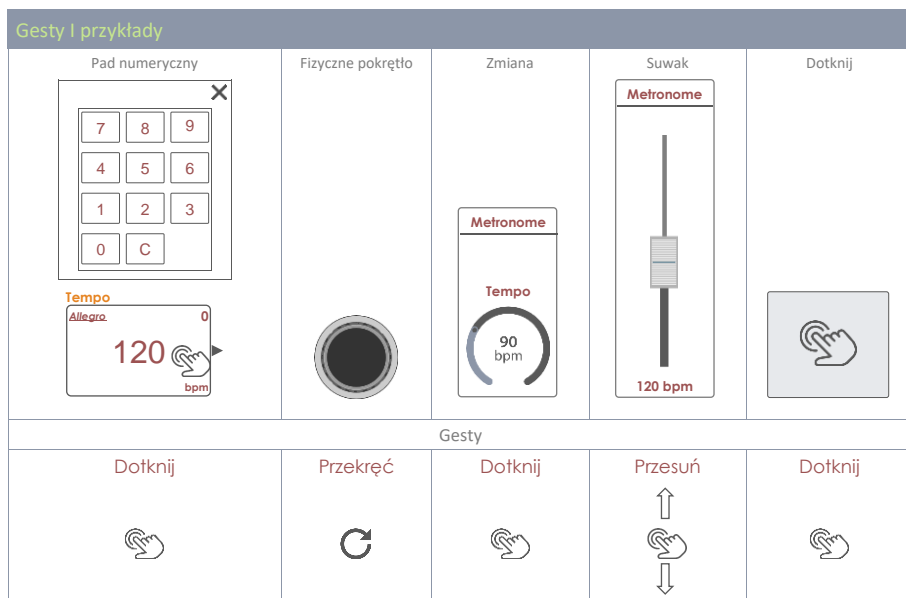

 Przycisk **[Podgląd]** w prawym dolnym rogu ekranu umożliwia słuchanie dźwięków aktualnie wybranego padu. Alternatywnie można również wyświetlać dźwięki w listach rozwijanych. Wybierz pad lub dźwięk na liście i dotknij przycisku podglądu. Pamiętaj, że nie potrzebujesz padu do korzystania z tej funkcji.

7.5.1 KLAWIATURA

Kilkakrotnie będziesz miał do czynienia z wbudowaną klawiaturą. Działa w taki sam sposób, w jaki jesteś przyzwyczajony do używania smartfonów lub tabletów. Na uwagę zasługuje sposób aktywacji funkcji caps lock. Stuknij raz strzałką zmiany, aby przełączyć na wielkie litery. Po wprowadzeniu pierwszej litery klawiatura automatycznie przełączy się z powrotem na małe litery. Aktywuj blokadę caps lock poprzez podwójne stuknięcie i dezaktywację caps lock, naciskając ponownie klawisz Shift.

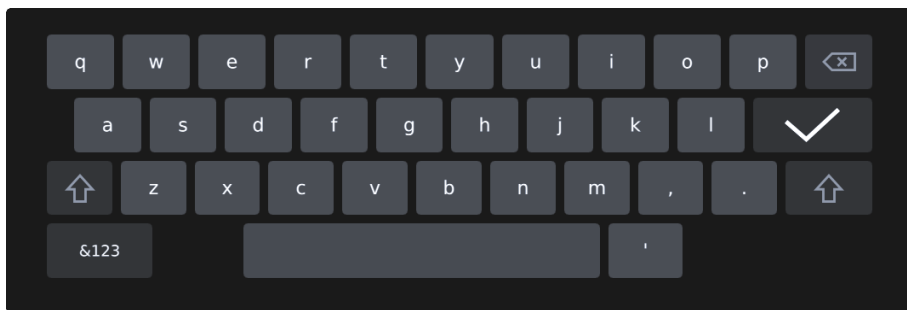

Główne funkcje klawiatury

Opis	Pojedyncze kliknięcie	Podwójne kliknięcie
 Małe litery	Wielkie litery	Caps lock włączony
 Duże litery	Małe litery	---
 Caps lock Włączony	Małe litery	---
 Skasuj	Usuń literę przed kursorem	---
 Potwierdź	Potwierdź i zamknij klawiaturę	---

8 TRYB WYSTĘPU (PERFORMANCE)



Tryb Performance zawiera wszystkie kluczowe funkcje, które skupiają się wokół grania na bębnach. Podczas codziennej rutyny będziesz przez większość czasu w tym trybie, który zapewnia metronom i odtwarzacz piosenek, które pomogą Ci opanować trudne ćwiczenia i piosenki. Wybierz zestaw perkusyjny i zdecyduj, czy chcesz, aby towarzyszyła Ci piosenka, metronom czy oba na raz. Tryb zawiera najpotrzebniejsze funkcje.



8.1 MODUŁ 1

8.1.1 DRUM KIT

Pierwsza sekcja to selektor **zestawu perkusyjnego (Drum Kit)**. Ten zestaw funkcji oferuje wiele opcji wyboru zestawów perkusyjnych:

- 1 Stuknij raz w polu **[Zestaw perkusyjny (Drum Kit)]** i dwukrotnie stuknij, aby wybrać zestaw z listy w **przeglądarce zestawu perkusyjnego (Drum Kit Browser)**. Skorzystaj z funkcji filtrowania w razie potrzeby.
- 2 Przeciągnij palcem poziomo po polu **zestawu perkusyjnego**.
- 3 Użyj **[-]** i **[+]**, aby poruszać się przód i w tył wewnątrz biblioteki zestawów perkusyjnych.
- 4 Jeśli już wiesz, który zestaw chcesz wybrać, możesz również dotknąć pola **[Number]** i bezpośrednio wprowadzić nowy numer zestawu. Klawiatura numeryczna zamyka się ponownie, dotykając raz pola numerycznego.

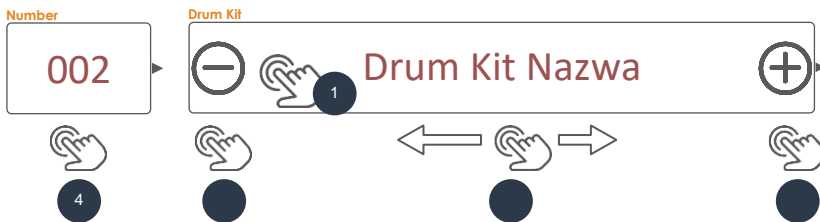

8.1.1.1 ZARZADZANIE ZESTAWAMI PERKUSYJNYMI (PRESETY)

Stuknięcie Pole **[Drum Kit]** otwiera **przeglądarkę zestawów perkusyjnych**, która zapewnia paletę funkcji do zarządzania biblioteką zestawów perkusyjnych, w tym eksport zestawu perkusyjnego.

Przeglądarka zestawów G9 Drum

Drum Kit Browser ✕

Sorted by

Preset Drum Kits
 User Drum Kits
 Name
 Category

Number	Name	Cat
001	Preset Drumkit Studio	AC
002	Preset Live Drum Kit	AC
003	Preset Jazz Kit	AC
004	Preset Fusion Kit	AC
005	Preset Electronic Kit	PR
006	User Drumkit Number 1 (Highlighted)	AC
007	User Drumkit Number 2	PR

Ściągnij
 Zapisz
 Nowy
 Nazwij
 Skasuj
 Export
 Import
 Dostępne funkcje



W zależności od typu zestawu (ustawienie fabryczne lub użytkownika) liczba funkcji jest różna. W **przeglądarce zestawów perkusyjnych** odpowiednia kategoria jest wyświetlana w prawej kolumnie listy zestawów, natomiast wybór funkcji znajduje się w dolnej części przeglądarki. Poniższa tabela zawiera listę **dostępnych funkcji** według kategorii zestawu perkusyjnego. Alternatywnie wybierz zestawu perkusyjne różnych kategorii i obserwuj, jak aktualizuje się funkcja przechowywania:

Przeglądarka zestawów perkusyjnych – dostępne funkcje

Kategoria	Funkcje						
	Ściągnij	Zapisz	Nazwij	Nowy	Skasuj	Export	Import
Presety fabryczne							
Presety użytkownika							

Przy stosowaniu jednej z tych funkcji do zestawu perkusyjnego ważne jest, aby zrozumieć, co tworzysz, zapisujesz, importujesz lub eksportujesz. Zestawy perkusyjne, jak pokazano w **przeglądarce zestawów perkusyjnych**, to po prostu zbiór parametrów zestawu perkusyjnego przechowywanych w tabeli. Te parametry definiują dźwięki, ale nie przechowują całych bibliotek próbek dźwięku. Szczególnie przy eksportowaniu zestawu perkusyjnego ważne jest, aby próbki dźwięków, o których

mowa, były zainstalowane, niezależnie od tego, czy są to dźwięki fabryczne, czy dźwięki pobrane ze sklepu **Sound Store**. Brakujące dźwięki w urządzeniu importującym spowodują puste **pola wyboru dźwięku (Sound Select)** w **Kit Editor** → **Moduł 2** → **Instrument Select**.

Drum Kit Parametry -Performance			
Mode/tryb	Parameter Values	Direct (Custom)	Preset (Indirect)
 Performance			
	Style Werbla (Snare Style) – wszystkie skorelowane parametry	•	
	Mikser (Mixer) – Suwaki głośności	•	
 Wskazówka	Każda zmiana wartości jednego lub więcej parametrów pokazanych powyżej spowoduje aktualizację nazwy zestawu perkusyjnego. Poprzednia nazwa gwiazdki (*) zostanie dodana do nazwy zestawu perkusyjnego we wszystkich polach zestawu perkusyjnego w interfejsie użytkownika. Gwiazdka jest przypomnieniem o konieczności zapisania zestawu perkusyjnego przed jego zmianą, aby zachować zmienione parametry zestawu na stałe. Instancje zestawu perkusyjnego znajdują się w: Performance → Moduł 1 → Drum Kit Kit Editor → Moduł 2 → Drum Kit		
Przykład	Drum Kit 		

Szczegółowe informacje na temat parametrów zestawu perkusyjnego można znaleźć w części **Edytor zestawu (Kit Editor)** w **instrukcji obsługi**. Najważniejszym zadaniem w trybie **Performance** jest możliwość wyboru zestawu perkusyjnego.

8.2 MODUŁ 2

W tym module możesz monitorować czułość triggerów, ustawiać parametry krawędzi werbla i miksować głośność wszystkich padów względem siebie.

8.2.1 OPCJE ZESTAWÓW (KIT OPTIONS)

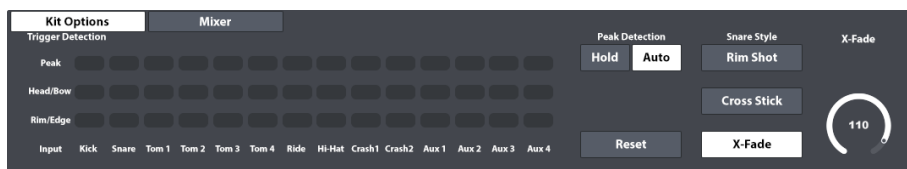

8.2.1.1 DETEKcja TRIGERÓW (TRIGGER DETECTION)

Panel Trigger Detection umożliwia monitorowanie ogólnych ustawień dla każdego pojedynczego Padu (kanału wejściowego) w trybie Performance. W tym widoku nie możesz zmienić ustawień triggera, ale otrzymasz wizualną informację zwrotną o czułości i poziomie. Czerwony kolor

podświetlony podczas umiarkowanego grania lub cichego jest wskaźnikiem, że pad jest zbyt czuły, a ustawienia triggera powinny być skorygowane.

Jak to działa:

Dla każdego kanału wejściowego wykryte wartości są pokazane jako wartości w skali kolorów od (0) do (127). Rzeczywiste wartości kolorów mogą się różnić w zależności od wybranego tematu interfejsu użytkownika. Odchylenia od normalnego schematu kolorów występują tylko w przypadku różnych rodzajów ślepoty barw. Regularny wygląd gradientów jest następnie zastępowany schematem z dostroczalnego spektrum kolorów danej grupy ludzi. Zobacz tabelę poniżej dla skal kolorów według motywu interfejsu użytkownika.

127



1

- **Peak (Przesterowanie):**
Zapala się tylko wtedy, gdy osiągnięto maksymalne wartości w opcji Naciąg/Łuk (Head/Bow) lub Obręcz/Krawędź (Edge/Rim) (Wartości 126 i 127).
- **Naciąg/Łuk (Head/Bow):**
Zapewnia w czasie rzeczywistym informacje o wartościach Naciąg/Łuk (Head/Bow) w normalnym zakresie od 0 do 125.
- **Obręcz/Krawędź (Rim/Edge):**
Zapewnia w czasie rzeczywistym informacje o wartościach obręcz i krawędź (Rim i Edge) w normalnym zakresie od 0 do 125.

Skale kolorów do wykrywania przesterowań według motywu interfejsu użytkownika

Wartość czułości MIDI	UI Theme		
	GEWA Red GEWA Classic GEWA White Tritanopia	Protanopia Deuteranopia	Grayscale
Peak/Przesterowanie (126-127)			
Normalna czułość (125)			
Czułość niska (1)			

8.2.1.2 DETEKJA PRZESTEROWANIA (PEAK DETECTION)

Funkcje wpisane w opcji **Peak Detection** obejmują wszystkie opcje regulacji pola **Trigger Detection**.

- **Hold (Zatrzymaj):**
Panel wykrywania trigger, aktualizuje i zapisuje swoją wizualną informację zwrotną do ręcznego zresetowania widoku.
- **Auto:**
Panel wykrywania trigger jest resetowany automatycznie po upływie około 3 sekund po wykryciu ostatniego sygnału wejściowego.
- **Reset (Kasowanie):**
Dotknięcie powoduje odświeżenie wartości w polu **Trigger Detection**.

8.2.1.3 STYLE WERBLA (SNARE STYLE) - RIMSHOT, CROSSTICK ORAZ X-FADE

Tutaj możesz szybko ustawić dźwięk obręczy na **Rimshot**, **Crosstick** lub **X-Fade**. X-fade to dynamicznie przetłacznik, który w zależności od prędkości i siły uderzenia, przywraca rimshot lub Crosstick. Jeśli wybierzesz x-fade, uaktywni się pokrętko o tej samej nazwie i pozwoli ci dostosować próg dynamiki Crosstick, zanim zmieni się on w Rimshot. Stuknij w pokrętko **[X-Fade]**, aby włączyć tłumik. Zauważ, że im wyższa pozycja fadera, tym trudniej uderzyć w obręcz, aby wywołać Rimshot. you.

8.2.2 MIKSER (MIXER)

Inną opcją jest regulacja głośności pochodzącej z dowolnego padu w stosunku do innych padów. Po prostu dotknij przycisku **[Mixer]** obok przycisku **Opcje zestawu (Kit Options)**, a następnie zmień wolumeny padów zgodnie z potrzebami. Inną przydatną funkcją jest grupowanie tomów lub talerzy. Ta funkcja pozwala na jednoczesną zmianę tomów i talerzy w stałej relacji/proporcji. **Dwukrotnie dotknij suwaka, aby przywrócić domyślne położenie fabryczne.** Zgrupowane tłumiki będą się wyśrodkowywać na wybranym suwaku, zachowując ich odstępy. Opuść mikser, dotykając **[Opcje zestawu (Kit Options)]**.

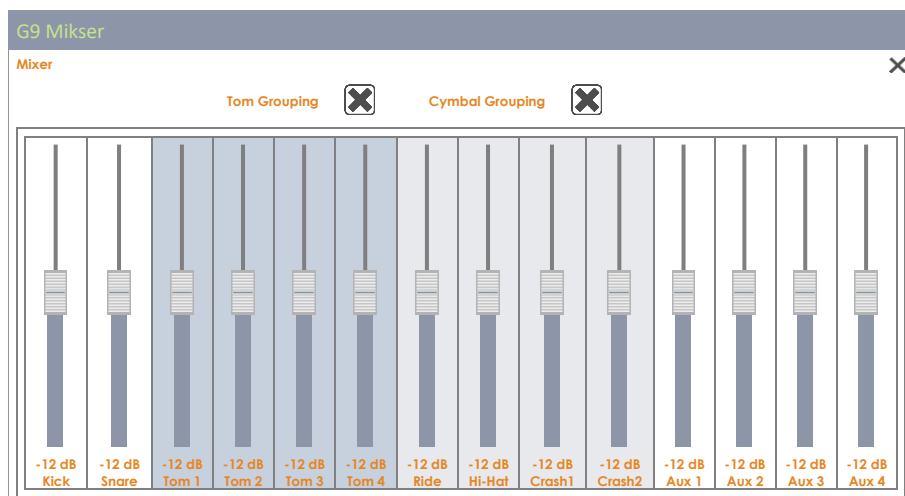

Należy zauważyć, że **styl werbel (Snare Style)**, a wraz z tym, **suwaki miksera** to parametry zapisane w zestawie perkusyjnym, podczas gdy grupowanie suwaków jest przechowywane w domyślnym banku danych urządzenia. Szczegółowy opis parametrów zestawu perkusyjnego jest opisany w trybie **edytora zestawu (Kit Editor)** ([Zobacz sekcję Drum Kit Presets - Parameters na str 41](#)).

8.3 MODUŁ 3

8.3.1 ODTWARZANIE UTWORÓW (SONG PLAYER)

Odtwarzacz utworów pozwala grać razem z podkładami i pomaga opanować trudne części piosenek podczas ćwiczeń. Wykorzystuje przeglądarkę **File Select** do ładowania wszystkich popularnych formatów plików audio, takich jak **mp3**, **wav**, **m4a** i **flac**.



Song Player – Obsługiwane formaty plików

Ikona	Ext.	Description/Opis	Developer/Dostawca
	*.aif	Audio Interchange File	Apple Inc
	*.flac	Free Lossless Audio Codec	Xiph.Org Foundation
	*.m4a	MPEG 4 Audio	International Organization for Standardization (ISO)
	*.mp3	MPEG Layer III	Moving Picture Experts Group
	*.ogg	Developers' Project Name	Xiph.Org Foundation
	*.wav	Waveform Audio File	Microsoft & IBM
	*.wma	Windows Media Audio	Microsoft

8.3.1.1 PRZEGLĄDARKA PLIKÓW (FILE SELECT BROWSER)

Przeglądarka File Select jest zaimplementowana w różnych aplikacjach w G9, takich jak **Odtwarzanie utworów (Song Player)**, **Czytnik PDF (PDF Reader)** lub **Narzędzia do importowania (Import Tool)**. Jednak w zależności od aplikacji otwiera się z różnymi aktywnymi filtrami, aby wyświetlać tylko odpowiednie typy plików. Jeśli chodzi o odtwarzacz utworów, wyświetla tylko wszystkie istotne pliki audio. W związku z tym niewłaściwe pliki są ukryte i wyzarzone.

8.3.1.1.1 WŁAŚCIWOŚCI

W lewym górnym rogu znajdują się przyciski służące do **wybijania nośników pamięci**, a także **funkcja wyszukiwania**, która może być wykorzystana jako alternatywa dla nawigacji po liniowej ścieżce. Wszystkie te przyciski są aktywowane **jednym dotknięciem**.

G9 File Select Browser/Przeglądarka plików – Wybór nośników lub szukanie



Intern



USB



Search

Navigation/Nawigacja – w górę ścieżki

SYSTEM/←



G9 File Select Browser/Przeglądarka plików (Audio)

File Select



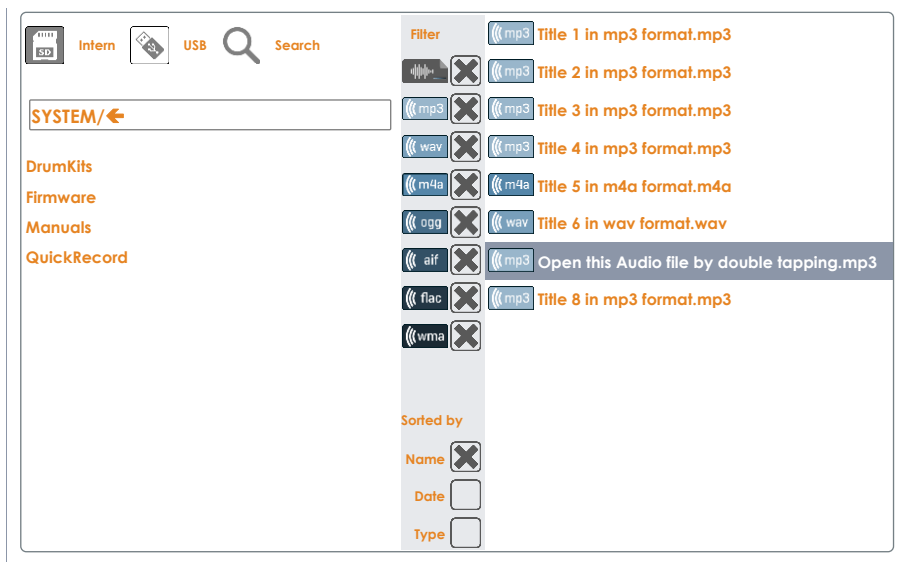

Lewa kolumna wyświetla wszystkie **foldery** w otwartym katalogu, prawa **kolumna zawiera** wszystkie **pliki** w nim zawarte. Stuknij dwukrotnie nazwę folderu, aby go otworzyć, przechodząc w dół ścieżki katalogu. Stuknij w **[biały pasek]** pod przyciskami **[SD]** i **[USB]**, aby przejść w górę ścieżki o jeden za każdym dotknięciem. **Panel pośrodku** zawiera opcje **filtrowania** i **funkcje sortowania**. Zaznacz pola zgodnie z potrzebami, aby wyświetlić zawartość w preferowany sposób.

8.3.1.1.2 OTWIERANIE PLIKÓW AUDIO

W **Song Player** postępuj następująco:

1. Stuknij pole **[Plik (File)]** w lewym górnym rogu, aby otworzyć opcję Wybierz plik.



2. Określ nośnik pamięci, dotykając raz **[USB]** lub **[SD]**.



3. Nawiguj do preferowanego pliku.
 - a. Kliknij dwukrotnie nazwy folderów, aby je otworzyć (lewa kolumna).
 - b. Przejdź w górę ścieżki, dotykając **[biały pasek]** (lewa kolumna).



4. Wybierz plik, który chcesz otworzyć, klikając dwukrotnie pozycje listy w prawej kolumnie.

8.3.1.2 FUNKCJE ODTWARZACZA PIOSENEK

Dzięki plikom audio masz dostęp do palety funkcji, które mogą towarzyszyć utworom za pomocą instrumentu, a także poprawiają rutynę ćwiczeń.

Główne przyciski odtwarzacza pokazano w poniższej tabeli:

Podstawowe funkcje Player	
	Odtwarzaj/Pauza (Play Pause)
	Stop
	przeskocz do przodu (skip forward)
	przeskocz do tyłu (skip backwards)
	Odtwarzaj/Stop (tryb sceniczny) - Play/Stop (On Stage Mode)

Zależność pracy odtwarzacza:

To, czy utwór rozpocznie się bezpośrednio po jego wyborze, zależy od stanu przycisków **Odtwarzaj / Pauza** i **Zatrzymaj**. Gdy utwór jest już odtwarzany, następny wybrany utwór rozpocznie się automatycznie. W przypadku **Pause** and **Stop** wybrany plik zostanie załadowany do odtwarzacza, ale rozpocznie się tylko przez ręczne dotknięcie **[Play]**. Ta właściwość zapewnia pełną kontrolę podczas ćwiczenia lub występów na scenie (ręczne uruchamianie w stanie wstrzymania lub zatrzymania), a szybkie zmiany plików pozwalają działać jako zwykły odtwarzacz audio.

Pomiń przyciski:

Zachowanie przycisków pominięcia zależy od wybranego trybu odtwarzania, a także stanu przycisków odtwarzania / pauzy i zatrzymania.

- **Odtwarzaj Raz** lub **Uaktywnij zapęlenie** (loop):
Piosenka zaczyna się od początku (Play) lub linia czasu jest resetowana do zera, a utwór zaczyna się od początku po dotknięciu **[Odtwórz]** ręcznie (Wstrzymany lub zatrzymany utwór).
- Wybór **folderu zapęlenia** (loop):
Odtwarzacz pomija wszystkie utwory w folderze. Zastosowanie mają ustawienia sortowania dokonane w przeglądarce plików.

8.3.1.2.1 OŚ CZASU

Gdy utwór jest odtwarzany lub jest zatrzymany / wstrzymany, możesz dotknąć i przeciągnąć poruszającą się kropkę w linii czasu, aby przejść do interesującego cię fragmentu. Alternatywnie, naciśnięcie dowolnego punktu na osi czasu, co spowoduje przesunięcie kropki do naciśniętego obszaru.

Obie metody działają w każdym stanie odtwarzania (gra, pauza, stop).



8.3.1.2.2 TRYBY ODTWARZANIA

Odtwarzacz piosenek oferuje trzy różne tryby gry:

Play Modes	
	Graj Raz (Play once)
	Zapętlaj aktywny utwór (Loop active song)
	Zapętlaj folder (Loop folder)

Aby wybrać tryb odtwarzania, dotknij raz odpowiedniej ikony.

8.3.1.2.3 TRYB DDTWARZANIA Z URZĄDZEŃ ZEWNĘTRZNYCH

Inne opcje wyboru utworów to np. podłączenie telefonu za pomocą **Bluetooth** lub portu **MIX IN** z tyłu konsoli. W tym przypadku funkcja pętli nie jest dostępna, a zamiast niej korzystasz z funkcji sterowania zewnętrznego odtwarzacza. Jak potączyć G9 z zewnętrznym urządzeniem za pomocą Bluetooth jest opisane w [12.4.3 Bluetooth na str 120](#).

8.3.1.2.4 ZAPĘTLENIE

 Zapętl pewną część utworu, dotykając [Loop/Pętla] w punkcie początkowym i końcowym. Zwiększ precyzję, korzystając z funkcji Vari Speed i wcześniej zwolnij tempo utworu. ([Zobacz sekcję 8.3.1.2.6 Zmiana tempa \(Vari Speed\) na str. 30](#))

Zapętlenie (Loop)	
	Sekcja pętli - dotknij 2 razy, aby ustawić znaczniki początku i końca
 A→B 	Wizualna pętla sprzężenia zwrotnego (punkty początkowe i końcowe)

8.3.1.2.5 SZYBKIE NAGRYWANIE (QUICK RECORD)

 Funkcja Quick Record/Szybkie nagrywanie umożliwia nagrywanie wszystkich wejść, w tym zestawu utworów oraz perkusji, jak również zapisywanie ich w pamięci wewnętrznej lub dowolnym urządzeniu USB. Naciśnij raz przycisk [**Szybki nagrywanie**], aby rozpocząć zapis. Kolejne stuknięcia zatrzyma nagrywanie i automatycznie zapisze plik w folderze systemowym „Szybkie nagrywanie” na wewnętrznej karcie SD. Kilka nagrań jest zapisywanych w odpowiedniej kolejności. Standardowy format pliku to wav. Oto przykład standardowego pliku szybkiego nagrywania/Quick Record:

- **Quick_Record-00001.wav**

Domyślnym katalogiem plików szybkiego nagrywanie / Quick record jest folder systemowy na wewnętrznej karcie SD. Ścieżka do katalogu to:

- **INTERNAL SD/SYSTEM/QuickRecord**

Jeżeli chcesz zmienić nazwę, przenieść lub usunąć nagranie to użyj Menedżera plików, aby zlokalizować folder szybkiego nagrywania. Idź do **Tools** ➔ **File Manager**. ([Zobacz sekcję 13.3 Menedżer plików \(File Manager\) na str 137](#))



8.3.1.2.6 ZMIANA TEMPA (VARI SPEED)

Tempo gry może zostać zmienione za pomocą funkcji **Vari Speed**. Stuknij raz w **[Vari Speed Dial]** i ustaw prędkość, przeciągając suwak w górę lub w dół. Suwak pozwala przyspieszyć lub spowolnić o 50% w porównaniu do nagranego tempa. Zauważ, że nawet jeśli prędkość się zmienia, wysokość pozostaje taka sama.

8.3.1.2.7 GŁOŚNOŚĆ UTWORÓW (SONG VOLUME)

Dostosowuje głośność odtwarzacza Song w stosunku do wszystkich innych wejść.

8.4 MODUŁ 4



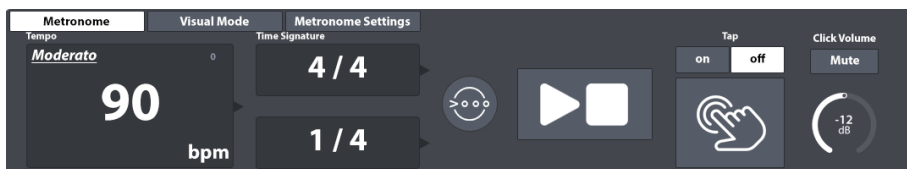







8.4.1 METRONOM (METRONOME)

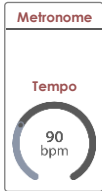

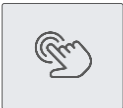

Ustaw tempo metronomu według poniższej instrukcji:

- Przekręć fizyczne pokrętko na panelu głównym.
- Dotknij raz pokrętko oprogramowania i przeciągnij suwak.
- Stuknij raz w pole **Tempo** i ustaw metronom za pomocą klawiatury numerycznej, która się pojawi.
- Wybij tempo uderzając palcem w ikonę **TAP**.
- Można również spersonalizować miejsce nabeicia tempa.

Ustawienie tempa metronomu

Pad numeryczny	Fizyczne pokrętło	Zmiana	Suwak	Dotknij
				
Gesty				
naciśnij 	Przekręć 	naciśnij 	Przesuń 	naciśnij 

Guziki metronomu

	Uderzaj, aby nabic tempo
	Start/Stop

Możesz także kontrolować **sygnaturę czasową (Time Signature)**, **interwał (Interval)** i **głośność kliknięcia (Click Volume)**. Stuknij raz w polu metronomu, aby wywołać opcję regulacji pokrętła i suwaka. Przycisk **[Wyciszenie (Mute)]** wyłącza dźwięk metronomu bez zmiany ustawień dokonanych w module 4.



Przycisk **Accent ONE** akcentuje pierwszy rytm aktywnego metrum. Domyślnie ta funkcja jest włączona. Wyłącz ją, aby uzyskać równomierny klik bez żadnych akcentów.

8.4.2 TRYB WIZUALNY (VISUAL MODE)

Istnieje również opcja trybu wizualnego, w której pojawią się liczby i podświetlają się z zgodnie z prędkością metronomu. Stuknij w przycisk **[Visual Mode]** obok zestawu funkcji **Metronome**. Pojawi się okno podręczne, które obejmuje moduł 3, pozostawiając pełny dostęp do wszystkich ustawień metronomu, które wpływają na tryb wizualny. Aby zobaczyć wszystkie efekty zmian w poniższej tabeli, najpierw aktywuj przycisk **[Odtwórz]**.

Aby zmienić wygląd trybu wizualnego, masz 2 opcje:

1. Zmień **sygnaturę czasową (Time Signature)** wzdłuż linii zgodnie z opisem w poprzedniej sekcji. Obserwuj, jak zmienia się zawartość trybu wizualnego.
2. Kliknij **[Mute (Wycisz)]** lub **[Unmute (Wyłącz wyciszenie)]**, aby wyłączyć lub aktywować dźwięk kliknięcia.



- i Wskazówka:** Tryb wizualny jest zaprojektowany tak, aby mógł być swobodnie dostosowany do potrzeb. Jest to jedyne wyskakujące okienko, które nie zamknie się automatycznie po opuszczeniu trybu. Jako narzędzie ćwiczeniowe uważa się, że zawsze pozostaje na wierzchu jako priorytetowe. Zawsze musisz zamknąć go ręcznie, naciskając **[x]** w prawym górnym rogu.

8.4.3 USTAWIENIA METRONOMU (METRONOME SETTINGS)

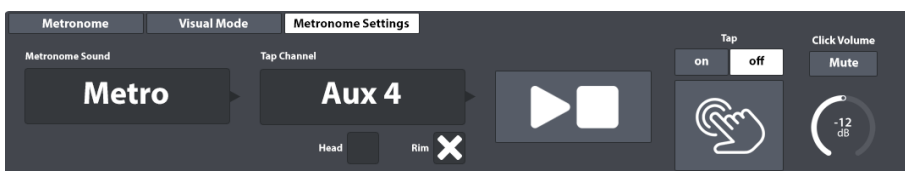

W tym zestawie funkcji można dostosować dźwięk metronomu oraz kanał do ustawiania prędkości metronomu, grając (**dołknij Kanał – Tap Channel**).

8.4.3.1 DŹWIĘK METRONOMU (METRONOME SOUND)

Dźwięk metronomu domyślnie ustawiony jest jako „**Metro**”. Można to jednak łatwo zmienić:

1. Naciśnij na pole **[Metronome Sound]**.



2. (Opcjonalnie) Podgląd dźwięków metronomu:
 - a. Aktywuj przycisk **[Odtwórz]** (upewnij się, że klik nie jest wyciszony).
 - b. Stuknij raz w dźwięk (Metro, Claves itp.).
3. Wybierz dźwięk, wykonując jedną z następujących czynności:
 - a. Wybierz preferowany dźwięk, naciskając dwukrotnie.
 - b. Zachowaj aktualnie wybrany dźwięk, naciskając **[x]** w prawym górnym rogu. Spowoduje to zamknięcie okna dialogowego.

8.4.3.2 TAP CHANNEL

You can also select a custom tap channel instead of using the **[Tap]** button. This function can be found under the function set **Metronome Settings**. To choose a custom tap device, proceed as follows:

1. Touch the field **[Tap Channel]**.



2. Select a pad from the drop down by double tapping.
3. Specify the desired pad component by checking one or both boxes below the **Tap Channel** field (Pad or Rim etc.).

All functions on the right-hand side of the **Tap Channel** field are identical with those in the function set **Metronome**. Thus, make sure that **Tap** is set to "on" and **Click Volume** is not muted.

9 EDYTOR ZESTAWU (KIT EDITOR)

W trybie Edytora zestawów można modyfikować bieżące ustawienia zestawu perkusyjnego, takie jak zmiana poszczególnych dźwięków padów, strojenie bębnow i dodawanie efektów. Ponadto możliwe jest dodanie korekcji i kompresorów do dźwięku każdego padu. Zamiast zmieniać wszystkie pady wraz z wyborem **zestawu perkusyjnego (Drum Kit)**, możesz dostosować każdy pad do pożądanego dźwięku. Użyj ustawień wstępnych dostarczonych jako punkt wyjścia. Na koniec dowiesz się, jak zapisywać, eksportować i importować zestawy bębnow z biblioteki zestawów perkusyjnych.



All settings made in the Kit Editor mode apply to the active Drum Kit, which is shown in the respective **Drum Kit** fields.

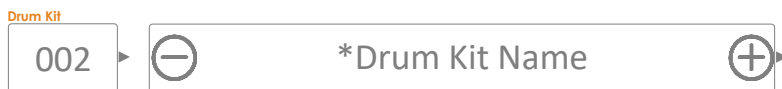

9.1 MODUŁ 1

9.1.1 CHANNEL SELECT

The main purpose of the channel select feature is to select connected pads for reasons of assigning different sounds (Kit Editor) or editing their trigger parameters (Trigger Settings).

9.1.1.1 INPUT CHANNELS

The Pad order from left to right matches the order of **Trigger Inputs** of the rear panel.

Select a connected pad by tapping the tile above the pad name. A selected pad is highlighted by a surrounding frame.



G9 Ports – Input Channels



The **Peak** row remembers the highest Velocity value detected while playing and for each pad separately. It works in the same way as the peak rows available in other modules and returns the **maximum velocity across all pad components**. Consequently, you are informed about a pad issue when spotting the peak color. The deeper analysis, however, must follow in **Trigger Settings** mode using the **Pad Monitor** (module 4).

In the **Peak** row the velocity scale of 0-127 is translated into color values which depend on the selected UI Theme. Check your UI Theme first to be able to interpret the colors returned under Peak. (see **General Settings** → **Moduł 4** → **Device** → **UI Theme**)

The following table shows the relation between velocity value, UI theme and color gradients used:

Skale kolorów do wykrywania przesterowań według motywu interfejsu użytkownika

	UI Theme		
Wartość czułości MIDI	GEWA Red GEWA Classic GEWA White Tritanopia	Protanopia Deutanopia	Grayscale
Peak/Przesterowanie (126-127)			
Normalna czułość (125)			
Czułość niska (1)			

9.1.1.2 AUTO SELECT

With Auto Select it is possible to select an input channel by playing the connected pad on one of its components. Turning this feature **[on]** will add the play-to-select feature to the standard select-by-tapping function on the screen. It is recommended to use this feature sparingly, since it can cause confusion when touching other pads accidentally.

9.1.1.3 PEAK DETECTION

With this function you can reset the peak monitor of the active module to the color value assigned to the velocity level of 0. This is especially important to check if altered trigger parameters work as desired. Tapping **[Reset]** refreshes the Peak Monitor and deletes the detection history.

9.2 MODUŁ 2

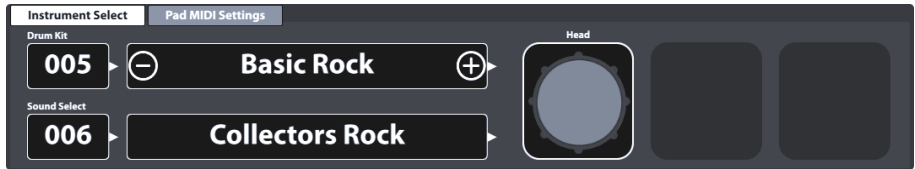

9.2.1 INSTRUMENT SELECT

9.2.1.1 DRUM KIT

The Drum Kit field is the starting point for any activity regarding sound design and trigger settings. All adjustments made in these modes apply to the selected drum kit. The **Drum Kit** field in **Kit Editor** mode is an instance of the **Drum Kit** field in **Performance** mode, so that they both update simultaneously when managing Drum Kits in one of them.

To select a drum kit in Kit Editor the following options are available:

- Tap the **[Drum Kit name]** field to open the **Drum Kit Browser**.
- Tap **[+]** or **[-]** in the **[Drum Kit name]** field to cycle through the drum kit library.
- Tap the **[Drum Kit number]** field to enter the desired kit number via the **Number Pad**.

The **Drum Kit Browser** is explained in detail in the section **Performance** mode (*Zobacz sekcję 8.1.1.1 Zarządzanie zestawami perkusyjnymi (Presety) na str. 22*). In Kit Editor, we will focus on preset management utilizing the functionalities of its Feature Shelf.

9.2.1.2 PAD COMPONENTS



The pad component icons are located on the right-hand side of module 2. You can tap on an icon to activate the component, giving access to its parameters in module 3. The appearance of the icons and their naming depends on the **Trigger Bank** assigned. Assigning a cymbal trigger bank will display Łuk/Krawędź/Kopułka (Bow/Edge/Bell) icons and cymbal parameters in module 3, even though the corresponding input channel is labeled as e.g. Snare. This means in most cases you can convert a pad input channel to a cymbal input and vice versa. However, not all components of the trigger bank might be accessible due to a different hardware design of the channel on the trigger board.

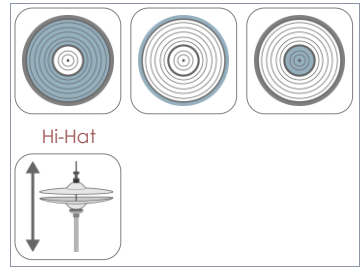

When gaining an understanding of the G9 Kit Editor, it is important to point out that all function sets and parameters of module 3 and 4 always refer to the selected pad under **Input Channels** and its active **Component** (component icon in module 2). The sound assigned to a component is shown in the **[Sound Select]** field. Sound name and component icon frames use the same **color values**, giving a quick visual feedback about which component is active. By changing either pad or component, sounds (module 2) and parameter values (module 3) will update accordingly.

To keep track of your sound settings, try to look at this mode as a cascade of Input Channel, Component, Sound and Parameters:



Every edit of sounds should follow the order shown above.

9.2.1.3 SOUND SELECT

The **Sound Select field** displays the sound assigned to the active pad component of the active pad (Input Channel). Sound names are highlighted in the color of the active component file to help the understanding of the connection between icon and sound name visible.



With the correct component selected, tap the **[Sound Select name]** field to open the **Sound Browser** and select a new sound from the sound library by double tapping on a list entry.

9.2.1.4 SOUND BROWSER – PROPERTIES

The sound browser lists all installed sounds by instrument categories, which are represented by the tabs shown on top of each sound list. By default, list entries are sorted by ascending internal sound numbers of the active instrument category (tab). This ordering can be changed by checking one of the options available under "**Sorted by**".

The alternative ordering options are:

- Instrument Name
- Category → Cat = **AC** (Acoustic), **EL** (Electronic), **PR** (Processed) or **FX** (Sound Effects)

Tabs and contents below the sorting options vary depending on the selected **Source**. The **Sound Browser** separates installed factory sounds (**Internal**) from imported user sounds (**Import**). Check the corresponding box to follow the specialties of each source in the next sections.

9.2.1.4.1 SOURCE – INTERNAL

Activating the **Internal** check box under **Source** will display the following instrument sound categories (tabs):

Sound Categories (Source = Internal)				
Kick Drums	Snare Drums	Toms	Ride Cymbals	Crash Cymbals
Hi-Hats	Cymbals SFX	Percussion 1	Percussion 2	Sounds SFX

Tap one of the category names to browse the contained sounds.

9.2.1.4.2 SOURCE – IMPORT

Activating the **Import** check box under **Source** will display all sounds imported via the **Narzędzia do importowania (Import Tool)** (Zobacz sekcję 13.5 Importowanie próbek dźwięku (Import Tool) na str. 149). The Tab "**Wave**" contains all imported **single layer wave samples** (created by users), whereas all other tabs contain imported **multi-layer sound banks** downloaded from the **GEWA Cloud**. Sounds downloaded from the **Cloud** will be filed under the correct Instrument category automatically during the import (Zobacz sekcję 13.6 Sklep (Shop) na str 155).

Sound Categories (Source = Import)				
Kick Drums	Snare Drums	Toms	Ride Cymbals	Crash Cymbals
Hi-Hats	Cymbals SFX	Percussion 1	Percussion 2	Wave

Tap one of the category names to browse the contained sounds.

9.2.1.4.3 ASSIGNING SOUNDS – SOUND GROUPING

The assignment of sounds via the sound browser is straight forward (**double tap a list entry**). However, there are some features built into the **File Browser** that allow for **batch assignment** to all components at the same time. The main feature is called **Sound Grouping**.

With sound grouping the user can pick all matching component sample sets of a recorded instrument at the same time and assign it to an input channel, regardless which component icon is active.

How it works:

In the **Sound Browser** list entry names end with a suffix indicating the type of component sample.

Regarding **cymbal samples** Suffix and component name are identical and selecting one component sample will select all other matching sample sets automatically.

Drums use the feature **positional sensing**, which detects the position of the stick on the Naciąg (Head) and blends samples from the side of the Naciąg (rich overtones) with focused samples from the center. To this end **head sounds** are further divided into sample sets to be used in conjunction with positional sensing

- Center-Side Blend (CS)

and sample sets that only consist of samples from one of the 2 zones:

- Center Only (C)
- Side Only (S)

The choice of one of the latter de facto deactivates positional sensing by returning sounds of the same zone, no matter which position on the head is detected.

Sound Grouping is designed to quickly pick all relevant samples that create the most realistic digital footprint of the entire sampled instrument. This means that it requires the **CS** samples for heads. Consequently, selecting Rimshot or X-Stick samples with **Sound Grouping on** will automatically select the matching **CS** version of the head samples. Starting with the head on the other hand will require to select a CS sample set to automatically select the corresponding Rimshot and X-Stick samples in the entry list of the **Sound Browser**. When assigning C or S head samples, sound grouping is ignored, and the chosen sample will only affect the active component.

G9 Sound Browser

Sound Browser ✕

Sorted by

Instrument Category

Number	Instrument	Cat
001	14" Collectors Maple C	AC
002	14" Collectors Maple S	AC
003	14" Collectors Maple CS	AC
004	14" Collectors Maple Rim	AC
005	14" Collectors Maple X-Stick	AC
006	14" US Vintage C	AC
007	14" US Vintage S	AC
008	14" US Vintage CS	AC
009	14" US Vintage Rim	AC
010	14" US Vintage X-Stick	AC
011	Broadkaster VBE CS	AC

Source

Internal

Import

Sound Grouping

The following table sums up the relationship between **Sound Grouping** and list entries of the **Sound Browser**:

Multi-Layered Samples - Drums					
Component	Naciąg (Head)			Obręcz (Rim)	
Sample Set	Center	Side	Center/Side Blended	Rimshot	X-Stick
Suffix	C	S	CS	Rimshot	X-Stick
Sound Grouping	No	No	Yes	Yes	Yes

 **Tip:** Access the Sound Browser directly by holding down your finger on a component icon for 1 second. Note that you only modify the component selected when Sound Grouping is unchecked. With Sound Grouping checked you assign a full set affecting each component, regardless by which component icon you have accessed the Sound Browser.

 **Hint:** If icons and their names don't match the pad (cymbal or drum) you want to edit, then check the trigger settings first. It is likely that the trigger bank assigned to the Input Channel is not correct. The trigger bank assigned to a pad determines the icons shown in the function set Instrument Select. Go to **Trigger Settings** → **Moduł 2** → **Trigger Selection** → **Trigger Bank** and tap on the **[Trigger Bank]** field to assign a matching Trigger Bank for the active Input Channel. As a result, all component icons under **Kit Editor** → **Moduł 2** → **Instrument Select** should update accordingly.

Every assignment made using the **Sound Browser** changes the parameter values of the active Drum Kit. To keep these changes, it is necessary to save the Drum Kit preset using the Drum Browser. This is the topic of the next section.

9.2.1.5 DRUM KIT PRESETS - PARAMETERS

Drum Kit Presets store values of all parameters associated with a recorded drum set. In the G9 interface, accessible drum kit parameters are spread over several thematically divided modes: **Performance**, **Kit Editor** and **Effects**. Every change in one of the relevant parameters will potentially require saving the active drum kit or creating a new one using the **Drum Kit Browser**, otherwise edits will be discarded as soon as you change the kit. Since the kit editor mode hosts most of the relevant drum kit parameters, we will have a closer look at parameters and preset management in this section.

Before we start, it is important to understand that drum kits listed in the **Drum Kit Browser** are simply a collection of drum kit related **parameter values stored in a table**. These parameters define the sounds used, but **don't store entire sound sample libraries**. Especially when exporting a drum kit, it is important that the referenced sound samples are installed on the importing device, whether they are factory sounds or sounds downloaded from the **Sound Store**. Missing sounds in the importing device will result in empty **Sound Select** fields in **Kit Editor** → **Moduł 2** → **Instrument Select**.

The following table shows all drum kit parameters across the different modes of the G9:

Drum Kit Parametry - Complete List			
Mode/tryp	Parameter Values	Direct (Custom)	Preset (Indirect)
 Performance			
	Style Werbla (Snare Style) – wszystkie skorelowane parametry	•	
	Mikser (Mixer) – Suwaki głośności	•	

Kit Editor			
	All sound referencing per channel	•	
	Pad MIDI Settings	•	
	All Mix/ Effect Sends parameters	•	
	All Sound Edit parameters	•	
	All Second Sound parameters	•	
	All Hi-Hat Volume parameters	•	
	Pad EQ - On/Off Switch	•	
	Pad EQ - All curve parameters	•	•
	Pad Compressor- On/Off switch	•	
	All Compressor parameters	•	•
Effects			
	On/Off Switch expression	•	
	FX Send Level Faders	•	
	Level	•	
	Pre-Delay (Ambience)	•	
	Gate Threshold (Instrument Reverb)	•	
	Send to Room Reverb (Multi FX)	•	
	Every other FX 2-4 parameter ...	•	•
 Wskazówka	<p>Każda zmiana wartości jednego lub więcej parametrów pokazanych powyżej spowoduje aktualizację nazwy zestawu perkusyjnego. Poprzednia nazwa gwiazdki (*) zostanie dodana do nazwy zestawu perkusyjnego we wszystkich polach zestawu perkusyjnego w interfejsie użytkownika. Gwiazdka jest przypomnieniem o konieczności zapisania zestawu perkusyjnego przed jego zmianą, aby zachować zmienione parametry zestawu na stałe.</p> <p>Instancje zestawu perkusyjnego znajdują się w: Performance → Moduł 1 → Drum Kit Kit Editor → Moduł 2 → Drum Kit</p>		
Przykład	<p>Drum Kit</p> <div style="border: 1px solid gray; padding: 5px; display: flex; align-items: center;"> ⊖ *Drum Kit Nazwa ⊕ ▶ </div>		

All relevant drum kit parameters of the Kit Editor can be found in modules 3 and 4 including the sound referencing of the **Sound Select** field (module 2).

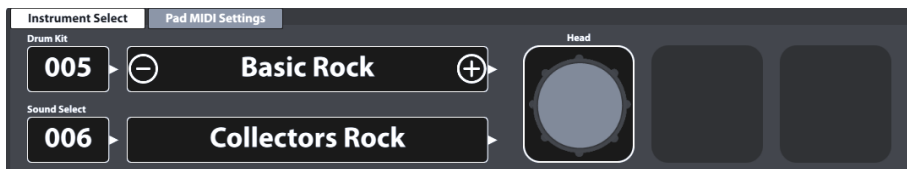

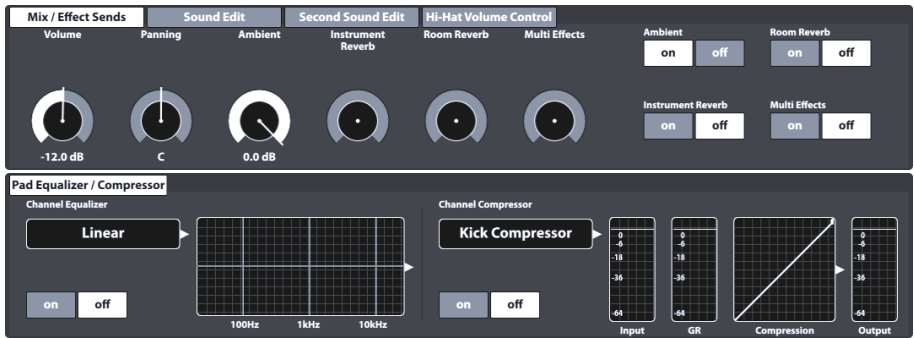

A detailed explanation of each parameter will follow in the respective modes. The following sub section assumes parameter values to be set and tackles the preset management of Drum kits such as the creation of new kits or the exchange of drum kit presets between different G9 devices.

9.2.1.6 PRESET MANAGEMENT - ELEMENTS

The parameters presented above form a Drum Kit preset, which can be saved as an individual user Drum kit. The G9 provides a variety of features to handle these presets. All these functions can be found in the **Drum Kit Browser** which is explained in detail in the Performance mode section of this documentation. The **Drum Kit Browser** can be accessed by tapping the **[Drum Kit]** field, which has an instance in Performance and **Kit Editor** mode. The relevant UI locations are:

Performance → **Module 1** → **Drum Kit**
Kit Editor → **Module 2** → **Drum Kit**

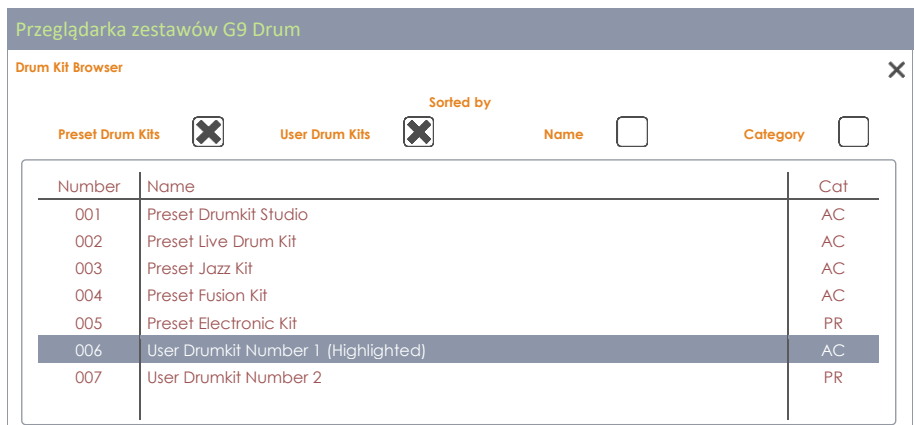
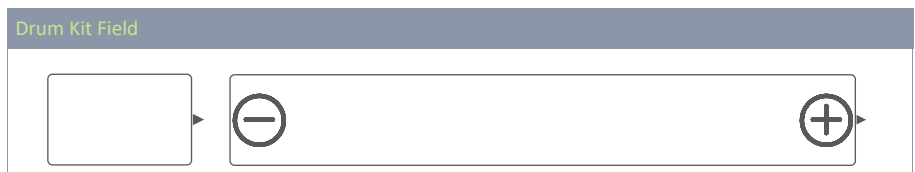



The bottom section of the Drum Kit Browser hosts the **Feature Shelf** which contains all preset management options. The number of options varies depending on the type of preset. The G9 distinguishes between **user presets** and **factory presets**. Factory presets cannot be edited or deleted; therefore, the palette of options is restricted. See the following table for comparison:

Przeglądarka zestawów perkusyjnych – dostępne funkcje							
Kategoria	Funkcje						
	Ściągnij	Zapisz	Nazwij	Nowy	Skasuj	Export	Import
Presety fabryczne							
Presety użytkownika							

The process of managing drum kits is the same for all features available. It starts by tapping the **Drum Kit name field**, followed by a selection of the kit in the **Drum Kit Browser** and ends with the choice of the function in the **Feature Shelf**. See the following sections for particularities of the individual functions.

9.2.1.6.1 LOADING DRUM KITS

Proceed as follows:

1. Tap the **[Drum Kit]** field to open the **Drum Kit Browser**.
2. Do one of the following:
 - a. Highlight a Drum Kit in the list by tapping once and tap **[Load]** in the Feature Shelf.
 - b. Double tap a list entry to load the Kit.

After step 2 the drum kit browser closes automatically, and the selected kit is active. The drum kit name in the drum kit field will update accordingly.

9.2.1.6.2 SAVING AND OVERWRITING DRUM KITS

In preparation please check if the **Drum Kit name** in the **Drum Kit field** is preceded by an **asterisk (*)**. Drum kits without asterisk do not possess any changed parameter values and consequently it is not necessary to save them. Saving or overwriting a drum kit will replace all stored drum kit parameter values by the values currently set in the UI (across all modes). With a visible asterisk proceed as follows:

1. Tap the **[Drum Kit]** field to open the **Drum Kit Browser**.
2. Determine whether you want to save the active kit, or whether you prefer to overwrite a different kit with the parameter values currently active in the Interface:
 - a. **Save** → Do nothing, the active kit is highlighted by default.
 - b. **Overwrite** → Highlight a Drum Kit in the list by tapping once.
3. Tap **[Save]** in the Feature Shelf.

After step 3 the drum kit browser closes automatically, and the parameter values of the drum kit selected in step 2 are overwritten by the current parameter values of the user interface.

9.2.1.6.3 RENAME DRUM KITS

Renaming a drum kit will affect the preset name only and retain individual parameter values. This option is not available for factory drum kits.

1. Tap the **[Drum Kit]** name field.
2. Tap once on a user drum kit in the drop-down list.
3. Tap **[Rename]** in the Feature Shelf.
4. Enter a new name for the preset using the keyboard.
5. Confirm by tapping **[OK]**.

9.2.1.6.4 DELETING DRUM KITS

Proceed as follows:



1. Tap the **[Drum Kit]** name field.
2. Tap once on a preset name in the drop-down list.
3. Tap **[Delete]** in the Feature Shelf.

9.2.1.7 DRUM KIT EXCHANGE

With drum kit exchange the G9 allows for exporting drum kits to create backup files of favorite kits including effects. This feature is hosted in the feature shelf of the **Drum Kit Browser** and allows for sharing your drum kits with other G9 devices via the built-in import feature. The relevant file format is **gdk** (GEWA Drum Kit) which is recognized in the file browsers of the user interface by its own icon. When exporting a drum kit, all presets are discarded, and parameter values are stored directly instead, resulting in **"Custom Setting"** contents of any preset field of the relevant drum kit parameters. This means that if presets are preferred you must store each preset individually after the import, or simply assign the underlying presets from your existing preset library again and save the kit.



Also, be aware, that a gdk file does not store any sound samples, but just the relevant drum kit parameters including sound referencing. A gdk file requires addressed samples to be installed in the sound library as either **factory sound** or imported sound from the **GEWA Sound Store**. In case of sounds not being installed on the target device, an import will result in empty **Sound Select** fields (Kit Editor) and the Pads won't be audible. *(Zobacz również sekcję 13.6 Sklep (Shop) na str 155 oraz sekcję 13.5 Importowanie próbek dźwięku (Import Tool) na str. 149)*

Drum Kit Exchange	
	gdk – GEWA Drum Kit File
	Drum Kit Export
	Drum Kit Import

The following sections guide you through the processes of drum kit export and import.

9.2.1.7.1 EXPORT

The export of a drum kit is straight forward. Tapping the **[Export]** icon in the feature shelf will store a copy of the drum kit in the default export folder on the internal SD Card. The corresponding directory path is:

INTERNAL SD/SYSTEM/DrumKits

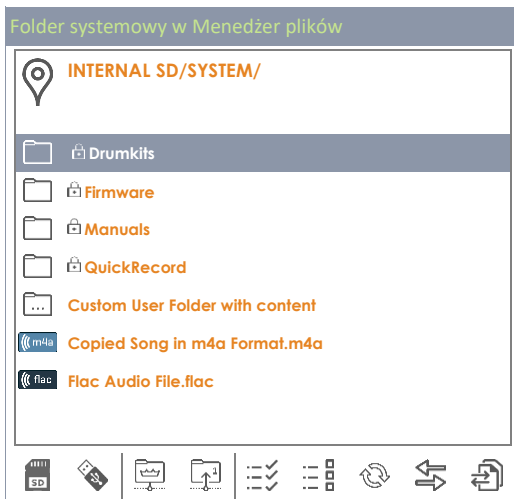

Use the **Menedżer plików (File Manager)** to copy the exported drum kit on a USB stick for import in other G9 devices (*Zobacz sekcję 13.3 Menedżer plików (File Manager) na str. 137*).

To export a drumkit in gdk file format proceed as follows:

1. Tap the **[Drum Kit]** name field to open the **Drum Kit Browser**.
2. Highlight the drum kit to be exported in the drop- down list (tap once).
3. Tap **[Export]** in the **Feature Shelf**.

A success message appears, and the drum kit is stored in the default drum kit folder.

i Tip: Tap the **[Import]** button in the feature shelf to verify the successful export. The import browser by default opens the standard export directory (DrumKits).

i Hint: A factory reset of the G9 will retain all data stored on the internal SD card. Your drum kit backups are protected.

9.2.1.7.2 IMPORT

G9 Drum Kit Import Browser



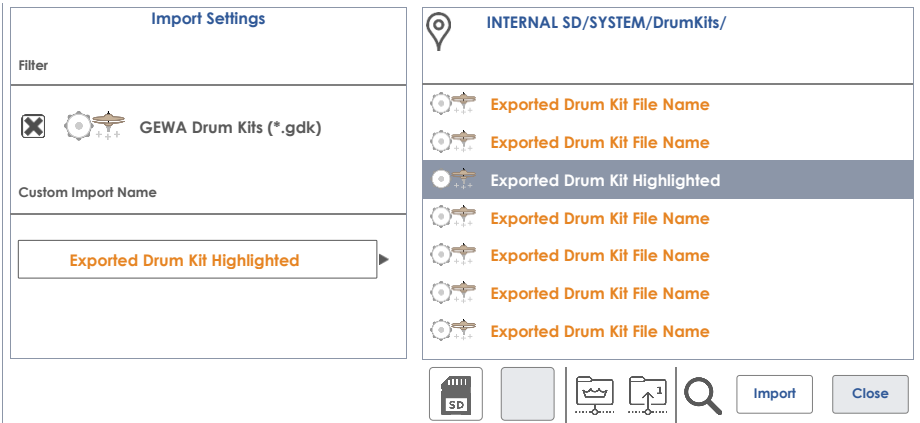

Drum Kit Import



The import is possible via USB or from the internal SD Card. In addition, it is possible to change the drum kit name stored in the *.gdk file. To import a drum kit, proceed as follows:

1. Tap the **[Drum Kit]** name field to open the **Drum kit Browser**.
2. Tap **[Import]** in the **Feature Shelf**.
3. Choose the storage medium where the file is stored (USB or SD).
4. Navigate to the drum kit to be imported using the browser on the right-hand side of the **Drum Kit Import** browser.
5. To select a file, choose one of the following options:
 - a. **Quick Import:**
 - i. Double tap the file to be imported. This will import the drum kit with the original export name. In case that the name already exists, the routine will add consecutive numbering.
 - b. **Custom Import** (rename option):
 - i. Highlight the file in the entry list (**tap once**). This will load the import name into the **Custom Import Name** field.
 - ii. Tap the **[Custom Import Name]** field to specify a custom import name using the keyboard.
 - iii. Confirm by tapping **[OK]** or tap **[Cancel]** to aboard.
 - iv. Tap **[Import]** in the bottom right corner of the **Task Bar**.
6. Tap **[Close]** in the bottom-right corner of **Drum Kit Import**.

Task Bar – Drum Kit Import

	Internal SD Card (opens root directory)
	External USB device (opens root directory)
	Go to root directory of the active path.
	Move up one level in the folder hierarchy
	Search
Import	Imports highlighted Kit into the Drum Kit Browser.

Close Closes the import dialogue (returns to Drum Kit Browser).

Characteristics using Search

Step 4 offers the option of using the search function as an alternative to the linear path navigation. To preserve the **Custom Import** option, it is not possible to directly import the drum kit from the search browser by double tapping. Selections made in the search dialogue will only load the chosen file into the field **[Custom Import Name]**. There are 2 alternative ways of loading the import file:

- Double tap an entry in list of search results
- Highlight an entry in the list of search results (tap once) Tap the hook **[✓]** in the **Keyboard**.

(Więcej informacji znajduje się w sekcji 13.3 Menedżer plików (File Manager) na str.137. oraz sekcję 13.4.1 Wyszukiwania (Search) na str 145)

File Name vs. Import Name

When exporting a drum kit, the import name and file name are identical. Renaming the file using **Menedżer plików (File Manager)** or any other application will only change the file name. When importing a drum kit, the import name will be identical with the name of the drumkit originally exported, no matter if the file has been renamed. Highlighting a drum kit file in the **Drum Kit Import** browser will load the import name of the selected file into the **Custom Import Name** field.

9.2.2 PAD MIDI SETTINGS

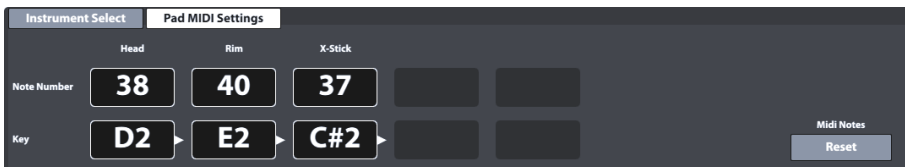

In this function set the user can set key values for **Midi OUT** configurations. **MIDI IN signals** regarding **trigger detection** of connected pads are fixed and can't be modified.

Tapping **[Reset]** in the right bottom corner will restore the factory configuration in which MIDI OUT assignments are configured equal to MIDI IN.

Settings made in this function set will affect both MIDI associated ports in the back of the console:



An example when a deviation from the internal key assignments of the G9 might be necessary is the fact that some manufacturers use a shifted key setup internally (e.g. assignment starts at a different octave of the keyboard). To make these devices compatible with each other, one them needs to change its external key assignment, otherwise the units would address other programs than the

intended. Please refer to the MIDI implementation available for the devices you want to interact with and find out whether a change in key values is necessary.

9.3 MODUŁ 3

9.3.1 MIX / EFFECT SENDS



This function set controls the volume of the individual pad components and provides global controls to mix adjustments made in the **Effects** mode with the dry sound of the sample. You can also turn on and off each module of the Effects Mode. This way you don't have to switch to the **Effects Mode** to access important, global controls. Consequently, all edits in values of slider positions and switches must be stored in the active drum kit, otherwise they would be discarded when changing the drum kit.

9.3.1.1 VOLUME (COMPONENT)

This volume slider affects the volume of the currently active pad **component** in the **Instrument Select** function set in module 2 of this mode. Here you can adjust the volume of the pad components in relation to each other whereas the **Mixer** ([Zobacz sekcję 8.2.2 Mikser \(Mixer\) na str. 25](#)) globally raises or lowers the volume of this relationship.

9.3.1.2 PANNING (INPUT CHANNEL)

As opposed to the Volume, **Panning** affects the active pad in the function set **Channel Select** as a whole. As a result, you pan all components at the same time. This is useful to create a surround feel of your kit. The Low Tom for instance might have dominance on the right-hand side of the Speakers/Headphones, as it sits on the right-hand side of the acoustic drum kit. Thus, in your right ear it will be perceived louder than in the left ear. The Snare on the other hand is in the center of the kit and tends to a panning value of C (Center). If you have set up your kit like a left-handed player this holds true for the opposite side. Panning contributes to replicating the acoustic environment behind the drum kit – the player's perspective.

9.3.1.3 EFFECTS

The dials **Ambient**, **Instrument Reverb**, **Room Reverb** and **Multi Effects** allow for gradually dialing in settings made in the **Effects** mode. As an instance, these sliders are exact representations of the corresponding pad slider in the **FX Send** mixer of the **Effects** module. On the right-hand side, you can turn on or mute the corresponding module in the **Effects** mode. Tap on the corresponding software dial and increase the amount of an effect by dragging the slider up. When muting an effect in this function set, the dial values are saved (provided you don't change the Drum Kit before saving), so that they are remembered when turning on the effect again. The on/off buttons are an instance of the module switches in the **Effects** mode. When you turn off a module in **Effects**, you also mute it in

the **Mix/Effect Sends** function set of the **Kit Editor** and vice versa. Effect dials don't distinguish between pad components but affect each component in the same way. For instance, it is not possible to assign a different ambience to a obręcze (rim) than to the matching head.

i **Tip:** All settings of this function set affect the currently active Input channel (pad) and/or its selected component as well as the active drum kit as a whole. Always be aware of the active drum kit, input channel and component, to keep track of your adjustments. Note that when changing the kit without saving, all adjustments are dismissed. Always save your work before moving on.

9.3.2 SOUND EDIT

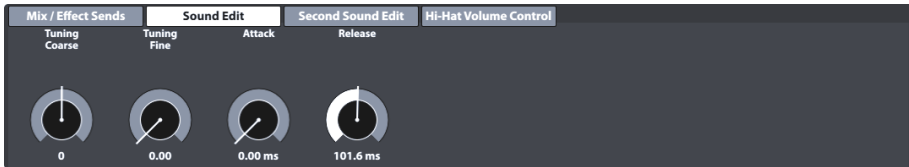

Although GEWA invested in multi-dimensional sampling of sounds, it is almost impossible to record any drum of any size and depth with any combination of differences in tension between top and resonant head. The number of required samples would be sheer endless and would exceed today's capacities of memory.

With this in mind, the function set **Sound Edit** offers tools to tweak the sound qualities of the recorded samples, such as changing the pitch and sustain of the drum. See all options below.

9.3.2.1 TUNING COARSE

This dial allows for rough tuning of the drum in **increments of semi tones**. With the default fader position in the middle of the spectrum you can tune up or down by 12 whole tones in each direction, giving you a full range of **24 whole tones (2 octaves)**. Tuning your sounds works on the **pad component** level, so that you can tune each component (e.g. Naciąg (Head) or Obręcze (Rim)) independently from each other.

9.3.2.2 TUNING FINE

From the chosen semi tone, you can fine tune the pitch. The default fader position is centered and has a full **range of one semi tone** (100 cents), allowing to tune up or down by a quarter tone (50 cents). The relative range of -50 to +50 cents is translated into fader scales from **0.00** (-50 cents) to **1.00** (+50 cents).

The following illustration shows how **Tuning Coarse** and **Tuning Fine** interlock giving full access to the full 2-octave spectrum in increments of one cent. Tuning up by 50 cents results in the same pitch as tuning down by 50 cents from the next higher semi tone:

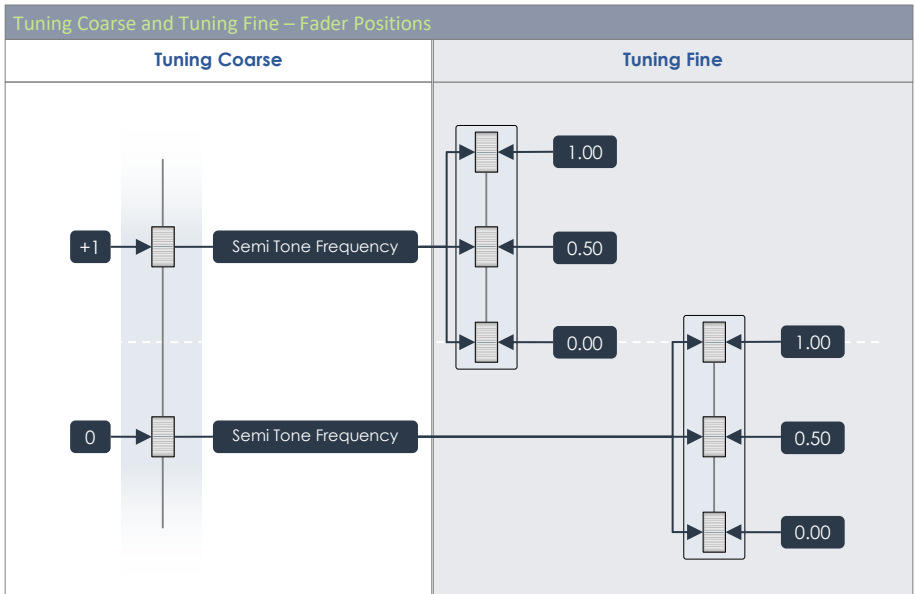

With the illustration in mind, the best practice for changing the pitch of the sound samples is consequently blocking out the rough pitch region with **Tuning Coarse** and fine tune it afterwards with the help of **Tuning Fine**.

9.3.2.3 ATTACK

Modify the attack of the drum by choosing a low fader position for tight and snappy feel and high fader positions for a “fluffy” feel with almost washed out attack.

9.3.2.4 RELEASE

Controls the length of sustain to emulate a muffled instrument. The natural sustain of the DRY sample (without effects) fades out quickly in low fader positions and slowly in high fader positions. Changing the fader position will add a predefined multiplier curve to the full sample amplitude, which is then moved inside the time interval of 15.5 ms – 6s after the attack by dragging the fader. The shape of the multiplier curve is a dynamic combination of a hold feature (multiplier = 1) and the tail with decreasing factors for longer time frames. This complex relationship is fixed and not editable in its parameters. The illustration above gives an idea, how the **Release** feature shapes the

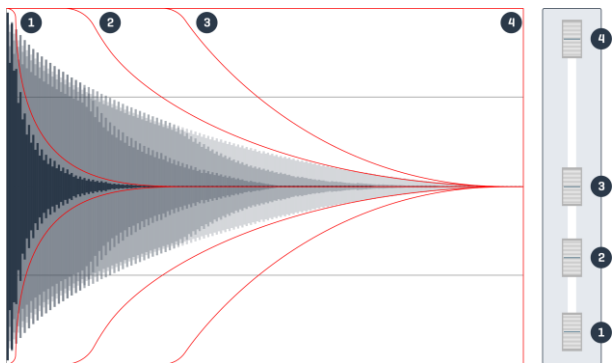

sample. The shape of the multiplier curve is a dynamic combination of a hold feature (multiplier = 1) and the tail with decreasing factors for longer time frames. This complex relationship is fixed and not editable in its parameters. The illustration above gives an idea, how the **Release** feature shapes the

amplitude of a sample in relation to the fader position. Curves shown are optimized for visualization purposes and don't claim to be exact.

9.3.3 SECOND SOUND EDIT

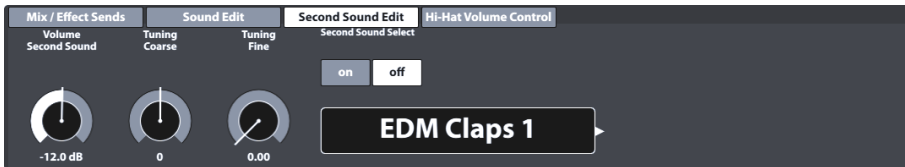

With Second Sound Edit you can layer a secondary sound on top of a pad component. An example would be layering tambourine jingles on top of a Hi-Hat to simulate a jingle ring mounted on the Hi-Hat rod. This option will affect the currently selected pad (check **Moduł 1** → **Input Channel**) and the active component in module 2 (Naciąg (Head), Obręcz (Rim) etc.). All dials and options of this function set work in the same fashion as described in [sekcję 9.3.2 Sound Edit](#). Once you are happy with the result, save the active drum kit before moving on.

9.3.3.1 VOLUME SECOND SOUND

While the volume of adjustments under **Sound Edit** is driven by the **Pad Mixer** (**Performance** → **Moduł 2** → **Mixer**), the layered second sound is driven by its own volume dial to adjust the volume in relation to the main sound of the component. The set relationship of the mix is then globally adjusted by the Mixer.

9.3.3.2 TUNING

This function set is equipped with the same functionalities for tuning as the function set **Sound Edit** ([Zobacz sekcję 9.3.2.1 Tuning Coarse oraz 9.3.2.2 Tuning Fine na str. 50](#)).

9.3.3.3 SECOND SOUND SELECT

Here, you determine the second sound sample to be assigned as well as its state when loading the drum kit (ON/OFF). That is to say that you can determine all qualities of the second sound and turn the second sound feature off before saving the kit, so that adjustments can be preconfigured and turned on quickly if desired. The **Second Sound Browser** contains all factory sounds. You can treat it as the **Sound Browser** with the difference that sound grouping and imported sounds are not available for layering ([Zobacz również sekcję 9.2.1.4 Sound Browser – Properties na str. 38](#)).



Kick Drums		Snare Drums		Toms		Ride Cymbals		Crash Cymbals	
Hi-Hats		Cymbals SFX		Percussion 1		Percussion 2		Sounds SFX	
Number	Instrument	Cat							
001	14" Collectors Maple C	AC							
002	14" Collectors Maple S	AC							
003	14" Collectors Maple CS	AC							
004	14" Collectors Maple Rim	AC							
005	14" Collectors Maple X-Stick	AC							
006	14" US Vintage C	AC							
007	14" US Vintage S	AC							
008	14" US Vintage CS	AC							
009	14" US Vintage Rim	AC							
010	14" US Vintage X-Stick	AC							
011	Broadkaster VBE CS	AC							

9.3.3.4 ASSIGNMENT OF SECOND SOUNDS

To assign a second sound to the currently active pad component (e.g. Naciąg (Head) or Obręcz (Rim)), proceed as follows:

1. Turn **[on] Second Sound Select**.
2. Choose a sample from the **Second Sound Browser** by tapping the name field.
3. Adjust the second sound layer volume in relation to the primary component sound by tapping the **[Volume Second Sound]** dial and move the slider as desired.
4. Evaluate your adjustments by tapping the **[Preview]** button or playing the according pad component.
5. (Optional) Tune all second sound samples using the **Tuning Coarse** and **Tuning Fine** features.
6. Select the feature state when loading the kit (ON or OFF).
7. (Optional) Select another Pad component under Instrument select in module 2 and repeat steps 1-4.
8. Save the drum kit or create a new kit to memorize your edits.



Tip: Assignment of second sounds will affect the active pad component only. Make sure you have the correct pad selected (module 1) and the desired component icon is highlighted in **Moduł 2 → Instrument Select**. It is recommended to keep **Auto Select** turned off (module 1) to avoid changing the pad accidentally.

9.3.4 HI-HAT VOLUME CONTROL

The screenshot shows the 'Hi-Hat Volume Control' interface with five sliders and their corresponding dB values:

Mix / Effect Sends	Sound Edit	Second Sound Edit	Hi-Hat Volume Control	
Bow Volume	Edge Volume	Bell Volume	Pedal Chick Volume	Pedal Splash Volume
-2.7 dB	-12.0 dB	-12.0 dB	-25.8 dB	-12.0 dB

This function set allows for adjusting the volume of different Hi-Hat components relative to each other. The accessible parameters are:

Hi-Hat Volume Control - Parameters	
Hi-Hat Cymbal	Hi-Hat Controller
Łuk (Bow) Volume	Pedal Chick Volume
Krawędź (Edge) Volume	Pedal Splash Volume
Kopułka (Bell) Volume	

Use the sliders to adjust all component sounds relative to each other and use the **Mixer** function of the **Performance Mode** to adjust the global Hi-Hat volume in relation to the other Input channels (Pads).

i Important: Don't change the drum kit before saving. Edits in Hi-Hat Volume Control values as well as Mixer values are stored with the drum kit. Changing the drum kit without saving it will discard all modified values and restore previous values when loading the kit again.

9.4 MODUŁ 4

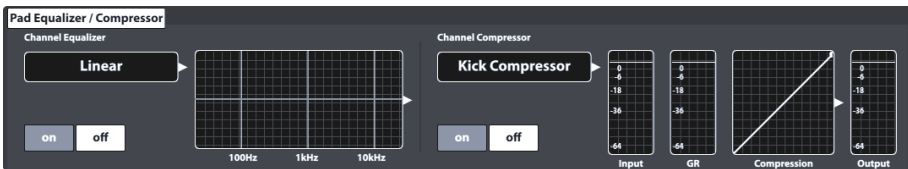

This function set hosts Equalizer and Compressor features which can be assigned to each Input channel displayed in **Module 1** of the **Kit Editor** Mode. Settings made in this module will be bundled with RAW MIDI signals and will consequently be audible in the direct outs when activated. *(Zobacz również sekcję 12.1.4 Routing Drums & Routing Others na str. 99)*

9.4.1 PAD EQUALIZER / COMPRESSOR

The G9 offers a 3-band full parametric equalizer function as well as a compressor for every input channel/pad. Both features are implemented as insert type features. This way it is possible to shape the sound of each connected pad individually. Pad EQ and compressors are part of the drum kit parameters and are part of the mix audible in direct outputs and digital outs as well.

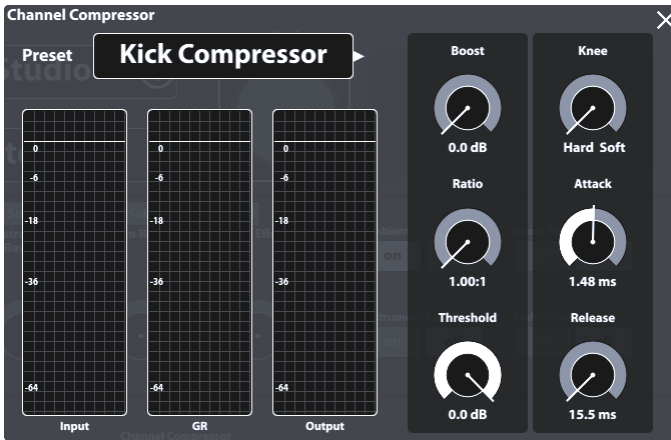
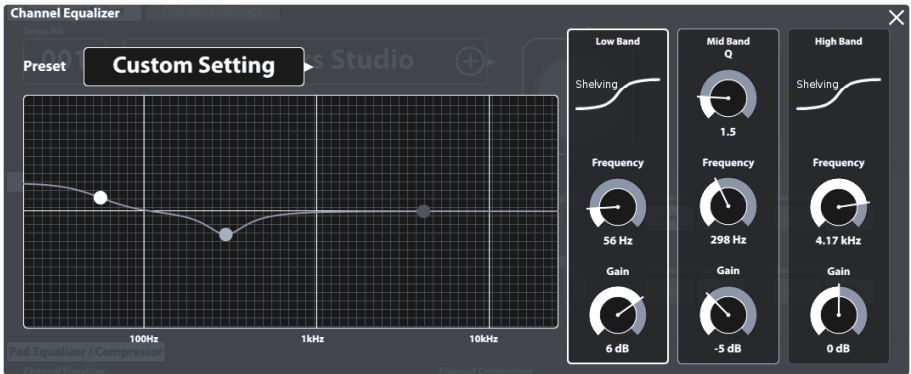

A selection of factory presets is provided to enhance your sound without deep knowledge in sound engineering. Load a preset and see how it affects the sound and the curve shapes of equalizer and compressor in module 4. The following presets are available:

G9 Presets – Pad EQ and Compressor	
Equalizer	Compressor
🔒 Linear	🔒 Kick Compressor
🔒 High boost 3dB	🔒 Snare Compressor
🔒 Bass boost 3dB	🔒 Bad Kick
🔒 Studio Snare A	🔒 Fat Snare
🔒 Studio Snare B	🔒 Drum Grouping
🔒 Drum Attack	🔒 Master A
🔒 Studio Kick A	🔒 Master B
🔒 Studio Kick B	🔒 Limiter A
🔒 Open Mix	🔒 Limiter B
🔒 Sweet Cymbals	🔒 Tube Saturation

Since the functioning of pad equalizers and pad compressors is identical with those available for the main stereo outputs (Master, Monitor and Headphones), we will focus on these features in **General Settings** mode. *(Zobacz sekcję 12.2.1.1 Equalizer na str. 105 oraz 12.2.1.2 Compressor na str. 107)*

10 EFEKTY (EFFECTS)



G9 jest wyposażony w 4 moduły efektowe. **Ambience** pochodząca ze znanego studia **Funkhaus Studios** w Berlinie. **Instrument Reverb** oraz **Room Reverb** to dwa tradycyjne moduły generujące pogłos / reverb. **Multi Effects (Multi efekt)** jest częścią tego trybu można sterować dowolnym efektem, który nie jest symulacją pomieszczenia lub pogłosem. Przykładami są efekty echa lub modulacja częstotliwości.

Ta sekcja zaczyna się od wyjaśnienia podstawowej koncepcji parametrów efektów, jak również typów parametrów, a następnie różnych sposobów zapisywania ich wartości/poziomów. Wreszcie każdy moduł efektów jest omawiany indywidualnie, koncentrując się na specyficznych właściwościach danego modułu.

The screenshot displays the G9 Effects interface with four active modules:

- FX 1 Ambient Samples:** Includes a Metronome (90 bpm), Ambient on/off, Pre Delay (0 ms), FX 1 Send, and Level (0.0 dB).
- FX 2 Instrument Reverb:** Includes Monitor Out, Mix-Input, Volume (-12 dB), Instrument Reverb on/off, Reverb Type (Hall Small), Pre Delay (18 ms), Reverb Time (8), Pre-High-Pass (118 Hz), High Shelf (-0.13 dB), High Damp (0%), Gate Time (off), Level (-30.7 dB), and Reverb Preset (Drum Hall).
- FX 3 Room Reverb:** Includes Headphone, Volume (-12 dB), Room Reverb on/off, Reverb Type (Hall Med), Pre Delay (28 ms), Reverb Time (68), Pre-High-Pass (157 Hz), High Shelf (6.00 dB), High Damp (13%), Level (-12.0 dB), and Reverb Preset (Concert Hall).
- FX 4 Multi Effects:** Includes Master, Mute, Volume (-12 dB), Multi Effects on/off, FX Type (Delay), Type (Mono/Stereo), Delay Time (75 ms), Feedback (24), Pre-Low-Pass (2.33 kHz), High Damp (100%), Send to Room Reverb (→ dB), Level (-12.0 dB), and Multi FX Preset (60s Slap back).

On the right side, there is a vertical toolbar with icons for Performance, Kit Editor, Effects, Trigger Settings, General Settings, Tools, and Preview.



10.1 EFFECT PARAMETERS

Effect parameters are the third group of parameters stored in drum kits. Hence the name drum kit parameters. Like the drum kit parameters of the **Kit Editor** mode, Effects allow for storing each parameter directly into the kit.

For effect parameters that are characteristic of the effect, the G9 also provides the **preset** option. This enables the user to copy effects from one kit to another. The indirect preset method of parameter storage creates an additional node in the parameter hierarchy, so that the drum kit stores the preset name, which references the different parameter values contained. The entire **Effects** mode contains only drum kit parameters.

The following table gives an overview of all drum kit parameters available in Effects, and for which of these parameters the **preset** option is available:

Drum Kit Parametry -Efekty			
Mode/typ	Parameter Values	Direct	Preset

		(Custom)	(Indirect)
 Effects			
	On/Off Switch expression	•	
	FX Send Level Faders	•	
	Level	•	
	Pre-Delay (Ambience)	•	
	Gate Threshold (Instrument Reverb)	•	
	Send to Room Reverb (Multi FX)	•	
	Every other FX 2-4 parameter ...	•	•
 Wskazówka	<p>Każda zmiana wartości jednego lub więcej parametrów pokazanych powyżej spowoduje aktualizację nazwy zestawu perkusyjnego. Poprzednia nazwa gwiazdki (*) zostanie dodana do nazwy zestawu perkusyjnego we wszystkich polach zestawu perkusyjnego w interfejsie użytkownika. Gwiazdka jest przypomnieniem o konieczności zapisania zestawu perkusyjnego przed jego zmianą, aby zachować zmienione parametry zestawu na stałe.</p> <p>Instancje zestawu perkusyjnego znajdują się w: Performance → Moduł 1 → Drum Kit Kit Editor → Moduł 2 → Drum Kit</p>		
Przykład			

10.2 EFFECTS MODULES – MUTUAL PARAMETERS

Every module of this mode can be switched **on** and **off** by the corresponding button on the left-hand side of the module. These buttons also have an instance in the **Kit Editor**, to preview effects without switching the mode. Level dials control the volume of each module, whereas **FX Sends** mixers allow for adjusting effect volumes of each pad individually. In other words: FX Sends control the effect "volumes" of the pads in relation to each other.

FX Sends 1-3

FX Send Levels ✕

Tom Grouping ✕

 Cymbal Grouping ✕

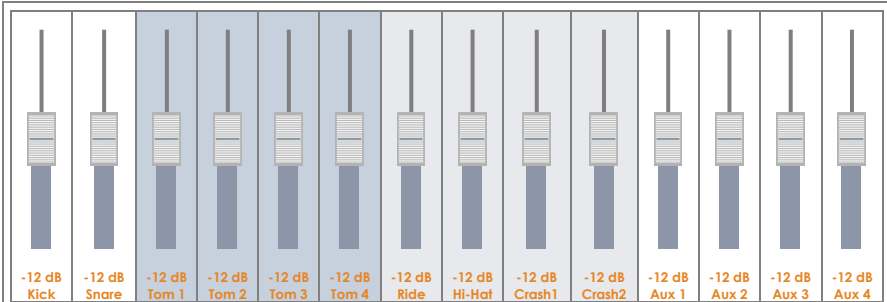

-12 dB Kick -12 dB Snare -12 dB Tom 1 -12 dB Tom 2 -12 dB Tom 3 -12 dB Tom 4 -12 dB Ride -12 dB Hi-Hat -12 dB Crash 1 -12 dB Crash 2 -12 dB Aux 1 -12 dB Aux 2 -12 dB Aux 3 -12 dB Aux 4

FX Sends Multi Effects with switchable Dry Signal:

FX Sends 4

Multi Effects Send Levels / FX 4

Tom Grouping Cymbal Grouping

-12 dB Kick
-12 dB Snare
-12 dB Tom 1
-12 dB Tom 2
-12 dB Tom 3
-12 dB Tom 4
-12 dB Ride
-12 dB Hi-Hat
-12 dB Crash1
-12 dB Crash2
-12 dB Aux 1
-12 dB Aux 2
-12 dB Aux 3
-12 dB Aux 4

Dry Signal

Dry Dry Dry Dry Dry Dry Dry Dry Dry Dry Dry Dry Dry Dry Dry Dry

i **Hint:** The default factory setting for FX Send sliders is -12 dB (centered). These values are overwritten as soon as you save the kit with deviant slider positions for the first time. Grouping of cymbals and toms is active by default and User/Device specific. The G9 remembers the last state for the next start. Grouping values are NOT stored with the drum kit!

10.3 EFFECT PRESET PARAMETERS

An effect module offers preset parameters, when there is a preset field on the left-hand side (modules 2-4). Such parameters are located inside the dividing, vertical bars and contain all functionalities which form the fundamental characteristic of the effect. The G9 offers two distinct ways of saving effect parameter values:

- Saving out a preset without overwriting the effect properties of the active kit.
- Directly into the drum kit (Save the drum kit in e.g. **Performance**)

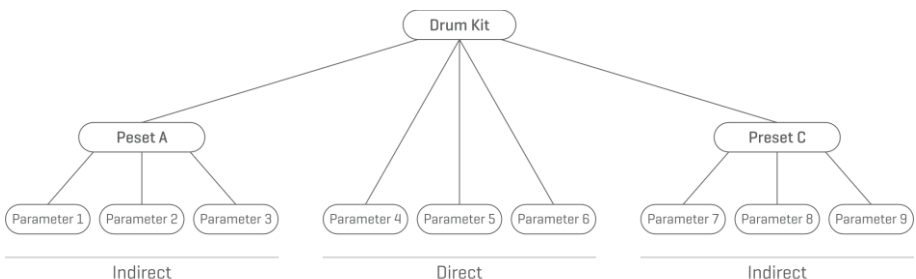

Chose a) if you want to make the effect parameter values of a module available for other drum kits as well or save the current parameters as a bookmark to explore other, alternative settings. Simply load the preset into a kit of choice and save the kit afterwards (alternatively create a brand-new kit). In case you neither save the kit, nor create a new one, changing the kit will restore the old

effect parameter values once you reload the drum kit in **Performance Mode** or **Kit Editor**. However, with a saved preset you have the chance to repeat the steps of loading the preset and saving the kit.

Choose b) if you just want to save the kit as it is including all effect parameter values. In this case it is recommended saving a new drum kit to avoid overwriting factory presets. When choosing this option, you can still save out the effect parameters as a preset later.

i **Hint:** Effect parameter values, which are stored directly into the kit and don't derive values from a preset, are marked with "**Custom Setting**" in the preset field of the effect module. This way you always know if you must save a preset before assigning the effect values to a different drum kit.

i **Important:** Don't change the kit before saving either the kit or its effect presets. Otherwise edits in effect values will be discarded!

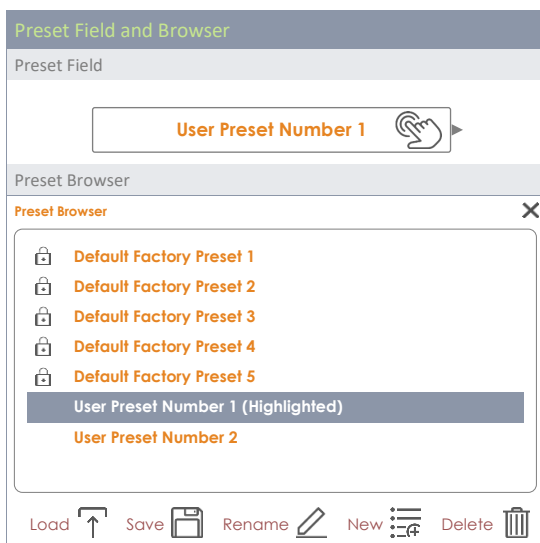

10.4 EFFECTS PRESETS

The G9 provides a variety of options to manage preset libraries. You can access the library and its functions by tapping on a **[Preset]** Field next to a group of preset parameters. The G9 distinguishes between **Factory Presets** (preceding lock icon) and **User Presets** (without lock icon).



Regarding user presets, the palette of options is extended, since factory presets are not editable. Tap on a user preset and a factory preset in the preset select dialog for comparison. See the following table for reference:

Preset Management - Dostępne funkcje					
Kategoria	Funkcje				
		Ściągnij	Zapisz	Nazwij	Nowy

 Presety fabryczne					
Presety użytkownika					

10.4.1 LOADING PRESETS

Proceed as follows:

1. Tap on the **[Preset]** field.
2. Tap once on the preset you want to load.
3. Tap **[Load]** in the Feature Shelf.

The dialog closes automatically, and the new preset is active. Save the drum kit to permanently connect the preset with the kit.

10.4.2 SAVING NEW PRESETS

In preparation please check whether the **[Preset]** field contains the name "**Custom Setting**". This indicates that values have changed and differ from those stored with the active drum kit.

With **Custom Setting** visible proceed as follows:

1. Tap on the **[Preset]** field.
2. Tap **[New]** in the Feature Shelf.
3. Name your preset using the keyboard
4. Confirm by tapping **[OK]**.
5. (Optional) Save the active kit to replace the preset currently stored.



Hint: A newly created effects preset will be added to the preset library only. It is not automatically stored with the active drum kit. To ensure that the new preset loads with the kit, you will have to additionally store the drum kit afterwards. If not, changing the kit will load all presets from the last saving.

10.4.3 DIRECT STORAGE OF PARAMETER VALUES

The G9 allows for storing parameter values directly into the Drum Kit without saving a preset. Instead of a preset name, the preset fields will display "**Custom Setting**". This is the case, when parameter values differ from an existing preset. It is still possible to save custom settings as a preset later and make certain parameter values available for other drum kits.

Note that preset types such as Routing Presets, Output EQ and Compressors are excluded from direct storage, since they are associated with the recording environment and not with the drum kit itself.

Two options of direct storage are available:

- a. Overwrite an existing drum kit
- b. Create a new kit

If you choose direct storage of parameter values proceed as follows:

1. Go to either

Performance → **Moduł 1** → **Drum Kit**

or

Kit Editor → **Moduł 2** → **Instrument Select** → **Drum Kit**

2. An asterisk (*) before the kit name indicates changes in directly storable values.
3. Tap the **[Drum Kit]** name field to open the **Drum Kit Browser**.
4. Choose one of the following options:
 - a. Overwrite an existing kit by selecting its name in the list and tapping **[Save]**.
 - b. Create a new kit by tapping **[New]** in the Feature Shelf, enter a name and confirm by tapping **[OK]**.

10.4.4 PRESET OVERWRITE

You can overwrite user presets with current values set in the interface. This function is not available for factory presets (preceding lock icon).

1. Tap the **[Preset]** field.
2. Tap on the preset name to be overwritten.
3. Tap on **[Save]** in the Feature Shelf.

10.4.5 RENAMING PRESETS

Renaming a preset will affect the preset name only and retain individual parameter values. This option is only available for user presets (without preceding lock icon).

4. Tap the **[Preset]** field.
5. Tap once on a preset name in the drop- down list.
6. Tap **[Rename]** in the Feature Shelf.
7. Enter a new name for the preset using the keyboard.
8. Confirm by tapping **[OK]**.

10.4.6 DELETING USER PRESETS

Proceed as follows:

1. Tap the **[Preset]** field.
2. Tap once on a preset name in the drop-down list.
3. Tap **[Delete]** in the Feature Shelf.

10.5 MODUŁ 1

10.5.1 FX1 AMBIENCE SAMPLES

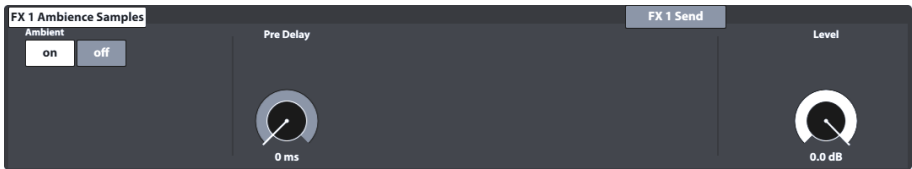

The Ambience module hosts room samples taken in Funkhaus Studios. Since a room responds to moving air in a characteristic and consistent manner, the possibilities of parameters are limited by the nature of the effect.

Ambience controls the time until the sound bounces off an obstacle resulting in an echo. The effect is designed to affect the sound of the kit globally, which follows the assumption that the whole kit is set up in the same room or environment. However, it is possible to adjust the volume of the effect for each pad using the **FX 1 Send Mixer**, which lets one turn off the effect by dragging the slider down completely for the pad of choice.

To adjust the **Ambience** (Echo) Effect of the kit, proceed as follows:

1. Turn **Ambient on**.
2. Set the **Pre-Delay** by dragging up the slider (range: 0-127 ms).
3. Use the **Level** dial to adjust the maximum volume of the Effect.
4. Tap on **FX 1 Send**, if you want to change the effect volume a pad individually (optional).
5. Save the effect with the drum kit once you are happy.

10.6 MODUŁ 2

10.6.1 FX 2 INSTRUMENT REVERB

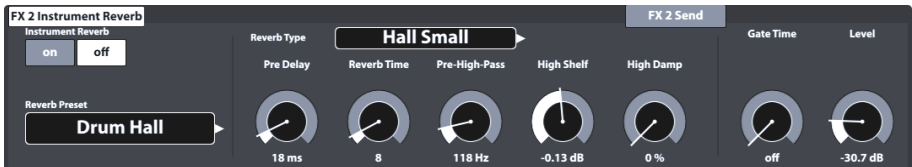

This module hosts classic and generic algorithms to simulate Instrument specific reverb. Some **Reverb Types** are traditionally generated electronically, whereas others (e.g. Plate) emulate mechanical devices designed to add artificial reverb to the dry recording.

The difference between Instrument Reverb and **Room Reverb** is more conceptual than a property. Does an instrument possess reverb if there was no room? This question is certainly a philosophic one. Both modules offer the same parameters except for **Gate Threshold** (Instrument Reverb only). With Room Reverb you can place the whole kit in an environment and with the addition of **Instrument Reverb**, it is possible to add reverb effects on top of the environment - selectively for each input channel. In that sense the additional parameter **Gate Threshold** is of an artificial nature and thus belongs to Instrument Reverb exclusively. Factory presets provided for Instrument Reverb focus on instrument specific effects but derive their characteristics from the same parameters and value ranges.

10.6.1.1 REVERB TYPES AND PARAMETERS

The following reverb types and parameters are available:

Reverb Types (Instrument and Room)	
Plate1 Small	Plates produce a mechanically generated reverb without early reflections. This is a simulation of a smaller size plate with a certain characteristic.
Plate1 Med	Plates produce a mechanically generated reverb without early reflections. This is a simulation of a medium size plate with a certain characteristic.
Plate1 Large	Plates produce a mechanically generated reverb without early reflections. This is a simulation of a large plate with a certain characteristic.
Plate2 Small	Plates produce a mechanically generated reverb without early reflections. This is a simulation of a smaller size plate with a different characteristic than Plate 1 Small.
Plate2 Med	Plates produce a mechanically generated reverb without early reflections. This is a simulation of a medium size plate with a different characteristic than Plate 1 Med.
Plate2 Large	Plates produce a mechanically generated reverb without early reflections. This is a simulation of a large plate with a different characteristic than Plate 1 Large.
Room Small	This is an algorithm simulating a small room where early reflections are accepted.
Room Med	This is an algorithm simulating a medium size room where early reflections are accepted.
Room Large	This is an algorithm simulating a large size room where early reflections are accepted.
Hall Small	Algorithm simulating a smaller concert hall with early reflections and a longer decay than room simulations
Hall Med	Algorithm simulating a medium size concert hall with early reflections and a longer decay than room simulations
Hall Large	Algorithm simulating a large concert hall with early reflections and a longer decay than room simulations

Each **Reverb Type** can be customized by the following parameters:

Reverb Types - Parameters				
Parameters	Description	Value Range	Storage	
			Direct (Custom)	Indirect (Preset)
On/Off	Activate/deactivate the reverb module globally	on/off	•	
Pre-Delay	The amount of time before the onset of reverb. Longer delays leave the dry sound untouched in its attack and preserve clarity of the sound. Short delays blend with dry signals earlier at the cost of crispness, if reverb starts before the fully developed attack of the dry sound.	0 - 250ms	•	•
Reverb Time	Controls the length of the reverb after Pre-Delay . Reverb time is also known as "Decay Time".	0 - 127	•	•
Pre-High-Pass	Hi-Pass pre-cuts the low dry-frequencies for the reverb algorithm (= Low Cut) and lets the high frequencies cut through. Set the frequency threshold below low frequencies are cut off. The fall-off curve avoiding sharp cuts is fixed and not editable.	0 - 1000Hz	•	•

High Shelf	Increases or reduces frequencies above the shelf frequency at 1.5kHz (Center frequency, turning point). Set positive values for increase and negative values for a decrease.	(-12) – (+6) dB (@1.5kHz)	•	•
High Damp	Filter that causes the high reverb frequencies to decay faster than the rest. The slider ranges from 0% (no damping) up to 100% (max damping)	0 - 100 %	•	•
Gate Threshold	Cuts off the reverb completely after dropping below the set Gate Threshold Level. A value of 0 switches the effect off, "On-values" range from (-114 dB) up to (-24 dB).	(-24) – (-114) dB	•	
Level	Level of attenuation of reverb. Controls the volume of the reverb compared to the dry sound.	-∞ - 0 dB	•	

10.7 MODUŁ 3

10.7.1 FX3 ROOM REVERB

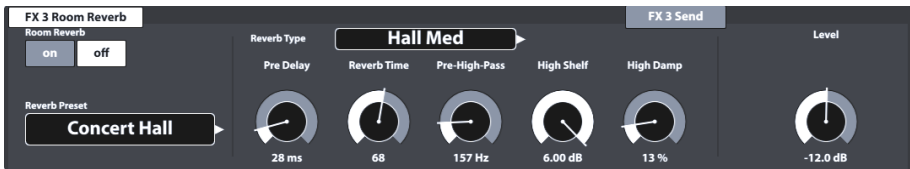

The features available in this module represent the generic counterpart of the **Ambience** module. It provides the same **Reverb Types** and parameters as **Instrument Reverb**, but with focus on the room specific qualities of reverb. Use this effect section to add reverb to a dry sound when ambience samples are not available, or simply to create sounds of traditional recordings with electronically generated reverb. Presets provided for this module reflect different environmental characteristics.

Since the functioning of this effect section is identical with the module **Instrument Reverb**, please refer to the previous section for delineation of concepts, explanation of reverb types and parameters.

10.8 MODUŁ 4

10.8.1 FX 4 MULTI EFFECTS

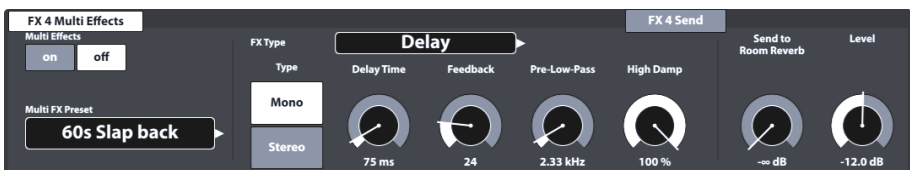

Effects in this module comprise everything that is not associated with **Ambience**, **Instrument Reverb** or **Room Reverb** as for example frequency modulation. Results are obtained by using algorithms to create a certain effect.

The following tables give you an overview of available algorithms and their parameters. Unlike the reverb modules the parameters of the **Multi Effects** module change depending on the algorithm selected. Mutual effect parameters are drum kit parameters and are stored directly in the kit.

Multi Effects – Mutual Parameters		
Parameter	Value Range	Description
Level	-∞ - 0 dB	Controls the Level of balance between Dry and Wet signal sent to the Mixer . If "Dry" is turned on in FX 4 Send (Zobacz na str. 58) (corresponds to "Side chain" configuration), Level will control the Balance between dry and wet signal sent to the Mixer . With "Dry" turned off, the effect is configured as an Insert type effect, where Send level and Level have identical functionality and contribute to the presence of the effect in the Mixer in the same fashion. Choose low fader positions for a quiet effect and high positions for more present effects.
Send to Room Reverb	-∞ - 0 dB	With Room reverb active for the Dry sound you might also feel the need of room simulation in multi effects as well to make both live in the same environment. Low fader positions will send a highly attenuated signal and will consequently add less room component to the effect. High slider positions will emphasize the environment in the effect mix
 Hint	These parameters are not part of the preset management but are stored as drum kit parameters using the direct method (Save the drum kit).	

The following parameters are associated with a **Drum Kit** and describe the fundamental characteristics of an effect. Therefore, both options of storage are available: direct method ("Custom Setting") and indirect method (presets). Edits in parameter values can be memorized by either saving the Drum Kit or creating/overwriting an effect preset.

Wah-Wah				
Parameters	Range	Unit	Dry/Wet	Description
Filter Type	Low Pass, Band Pass			Choose between a High Cut (Low Pass) or a Band Pass Bell filter. Underlying constants: Transition steepness: 12 dB (Low Pass)
Frequency	100Hz - 8kHz	Hz		Depending on the chosen Filter Type , this parameter sets the center frequencies of Low Pass or Band Pass for the stroke velocity value of 0 (starting point).
Resonance	1-127			Corresponds to the "Q" factor in Equalization. This parameter controls the width of the bell filter shape (Band Pass) and in case of choosing the Low pass option, Resonance will control the bell shape of the "overshooting" at the filter Frequency . Set the width of the bell filter shape from 0 (no resonance, wide) in the lowest slider position up to 127 (max resonance, narrow) in the highest slider position.
Sensitivity	0-100	%		Sensitivity defines to what extend the dynamics of a stroke on a pad (velocity) is allowed to drive the movement of the specified filter along the possible frequency spectrum. The filter is defined by the parameters Filter Type , Start Frequency and Resonance .

				Technically, Sensitivity works as a multiplier (attenuator) for the effect intensity at a specific stroke velocity level. Example: With Sensitivity set to 50%, a stroke on a pad with maximum velocity of 127 will cause the filter to move only halfway along the possible frequency range in the specified Direction , whereas the same stroke velocity with Sensitivity of 100% would exhaust the full frequency spectrum possible. Values range from 0 (off) up to 127 (100%).
Direction	Up, Down			Set the direction of movement for the Filter Type starting at Frequency .
Decay	(-10) ms – (+5) s	s		Decay determines how fast the envelope follower , which controls the filter activity or attenuation, returns to its starting position after having tracked the maximally allowed movement defined by stroke Velocity and Sensitivity . Aside from the filter movement, you can additionally control the presence of the filter effect in the mix by adjusting the decay rate of the envelope follower. Values range from -10 ms (fast) up to 5 seconds (slow) with a nonlinear progression of decay time while moving the slider.

Distortion / Saturation

Overloads the audio signal with gain and adds additional harmonic frequencies to the mix, resulting in a fuller but in case of distortion also edgier sound. This method is prone to scaling up frequency amplitudes along the frequency spectrum, with the result, that the amplitude would surpass 0 dB at more and more frequencies. Consequently, audio **Clipping** is forced to generate the effect of added harmonics in the audio mix.

Two methods are provided, who differ in the way of dealing with clipping: **Distortion** and **Overdrive**. While **Distortion** radically levels amplitudes crossing 0 dB (**hard clipping**), **Overdrive** rounds off the amplitude at the boundaries of bandwidth, where clipping would occur (**soft clipping**). Which method provides the better results depends on the audio material (samples) utilized.

Parameters	Range	Unit	Dry/Wet	Description
Type	OD, DS			Choose between two methods of effect generation with distinct characteristics: OD (Overdrive) and DS (Distortion) . While Overdrive models the characteristics known from tube amplifiers, Distortion provides the characteristics of distortion typical of Transistor amplifiers.
Drive	0-100	%		This parameter controls the intensity of the effect (scaling up frequency amplitudes). Values range from 0% (linear) up to 100% (max Drive amount).
Frequency	250Hz - 8kHz	Hz		This parameter determines the frequency spectrum affected by the chosen effect Type . If you prefer to saturate only the lower end of the frequency spectrum, set the desired filter frequency for the underlying Low Pass filter with transition steepness of 12 dB.
Post Gain	(-∞) - 0	dB		Adding this effect type will considerably amplify the output signal. With post gain you can attenuate the mix. Values range from -∞ (muted) up to 0 (min attenuation)

Chorus

Creates a fuller sound by the illusion of multiple instruments being played simultaneously. The effect is achieved by doubling the dry sound and offsetting the detuned duplicate slightly in time (fixed delay time of 20 ms). The

frequency modulation of the duplicate signal is controlled by different LFO waveforms available.

Parameters	Range	Unit	Dry/Wet	Description
Type	Sine, Triangle			Determines the displacement waveform of the underlying Low Frequency Oscillator (LFO). This is a control curve outside the audible spectrum of human hearing (below 20 Hz, see also Modulation Rate). With the waveform you can give the effect distinct characteristics. Sine produces smooth characteristics, while triangle allows for more earthy characteristics of the delayed duplicate.
Modulation Rate	0-10	Hz		Controls the speed of LFO displacement and thus the speed of the wavering sound. This parameter controls the period of the LFO waveform.
Modulation Depth	0-127			Controls the intensity of the effect by adjusting the height of the LFO amplitude. The parameter values range from 0 (off) to 127 (intense).

Flanger

Doubles the dry signal and displaces it within a short delay time, so that dry signal and duplicate are not perceived as 2 distinct sounds. Compared to similar effects, Flangers delay the duplicate signal slightly more than traditional Phaser effects and Flangers accept feedback signals to process the modulation, resulting in an effect similar to the sound of a jet plane. Flangers use cone filtering for the frequency modulation of the duplicate signal. The dynamics of filter movement from high frequencies to low frequencies is controlled by an LFO (sine).

Parameters	Range	Unit	Dry/Wet	Description
Modulation Rate	0-10	Hz		Controls the length of the LFO waveform period and thus the frequency of the generated sweep.
Modulation Depth	0-127			Controls the intensity of the effect by adjusting the height of the LFO amplitude. The parameter values range from 0 (off) to 127 (intense). This parameter controls how noticeable or settled the effect is. Starting at high frequencies you specify how far the underlying LFO driven Comp Filter is allowed to travel into the low frequency spectrum while it is sweeping back and forth.
Delay Time	0.125 -10	ms		Specify the delay time for the offset and modulated duplicate signal.
Feedback	0-127			Controls the number of signal copies feeding back into the effect unit to enhance the comp filter effect, until the effect fades out. Choose low fader positions for less feedback signals and high fader positions for lots of feedback signals and strong enhancement of the filtering.

Phaser

The G9 models the effect using a 6-notch filter directly applied to the dry signal. Like **Wah-Wah**, the effect is generated by "brushing" with the filter through the frequency spectrum. However, while the dynamics of movement of Wah-Wah are controlled by the intensity of the stroke, the movement using Phaser is controlled by a sine LFO waveform. In comparison to **Flangers**, Phasers allow for filter movement around the notch frequencies, whereas filters creating the Flanger effect start at high frequencies and travel down to lower frequency spectrums. The parameters provided for Phasers model the movement of the filter as well as the shape of the filter (Resonance).

Parameters	Range	Unit	Dry/Wet	Description
Modulation Rate	0-10	Hz		Controls the length of the LFO waveform period and thus the frequency of the generated sweep.

Modulation Depth	0-127			Controls the intensity of the effect by adjusting the height of the LFO amplitude. The parameter values range from 0 (off) to 127 (intense).
Resonance	0-127			Emphasizes certain frequencies in a period or sweep. Corresponds to the Q factor in Equalization. Set the width of the bell filter shape from 0 (no resonance) in the lowest slider position up to 127 (max resonance, wide) in the highest slider position. With this parameter you control the shape around all peaks of the filter at the same time.

Auto Pan				
Pans the sound between the left and the right speaker in 180° out of phase. The volume of both channels (Left and right) is driven by a sine LFO waveform.				
Parameters	Range	Unit	Dry/Wet	Description
Modulation Rate	0-20	Hz		Controls the length of the LFO waveform period and thus the frequency of the alternating effect.
Modulation Depth	0-127			Controls the intensity of the panning effect. Values range from 0 (equals Mono) to 127 (full alternation between 63L and 63R values)

Bit Crusher				
This effect adds edginess to your sound by reducing the waveform resolution of the signal. (along the amplitude and the period).				
Parameters	Range	Unit	Dry/Wet	Description
Bit Resolution	0-16	bit		This parameter pixelates the audio signal and reduces the resolution of the signal (vertical direction, Bit Depth). Values: 0 (no reduction), 1 bit up to 16 bits
Down Sampling	1-16			Reduces the resolution of the wave period by lowering the sampling rate. (horizontal direction, quality) Values are defined as a factor of reduction and range from 1 (no reduction) up to 16 (reduction down to 1/16 of the original sampling rate)
Brightness	0-100	%		Bit Resolution and Down sampling are prone to increasing the proportion of high frequencies in the output signal. Brightness adjusts the frequency of a Low Pass (High Cut) filter with a transition steepness of 12 dB. Low slider positions correspond to low filter frequencies and less high frequencies, whereas high slider positions translate to high filter frequencies and thus, filter less highs.

Delay				
Records a segment of the played sound and plays it back repeatedly (multi-echo)				
Parameters	Range	Unit	Dry/Wet	Description
FX Type	Mono, Stereo			Mono creates a mono signal audible on both speakers simultaneously. In stereo mode the delayed signals alter between the left and the right speaker. The Mono signal is moved to the left speaker and the second signal for the stereo effect is inserted in between the Mono signal on the opposite speaker. Consequently, this doubles the feedback frequency (or cuts the Delay Time into half).

Delay Time	1-1365	ms		Control the time in-between repeats.
Feedback	0-127			Controls the number of repeats until the effect fades out. Choose low fader positions for less repeats and high fader positions for lots of repeats.
Pre-Low-Pass	2-8	kHz		Cuts the high frequencies of the dry signal above the set cut frequency. Only frequencies below the threshold frequency are passed on to generate the effect. The slope steepness of the filter is 12 dB. Pre-Low-Pass only works on the delayed sound. The dry signal itself is not affected.
High Damp	0-100	%		Filter that causes the high reverb frequencies to decay faster than the rest. The slider ranges from 0% (no damping) up to 100% (max damping). Choose higher values to create a delay that runs away into distance, while low damping values let the delay stay in the vicinity of the dry sound.

11 USTAWIENIA TRIGGERÓW (TRIGGER SETTINGS)



W trybie **ustawień triggerów** można dostosować zachowanie/czułość elektrod, dodatkowo dostosowując zestaw elektronicznej perkusji wg. potrzeb. Zauważ, że trzy górne pokrętki zmieniają się, aby wpłynąć na suwaki **poziomu (High Level)**, **progowego Naciąg/Luk (Head/Bow Threshold)** i **czułości Naciąg/Luk (Head/Bow Gain)**.

Zaleca się używanie ustawień fabrycznych dla elektrod (jeśli są dostępne) poprzez przeglądanie menu **Trigger Bank** i **Setup**. Jednak G9 oferuje szereg funkcji do kalibracji dowolnej analogowych padów z triggerami do twojego stylu gry. Dowiedz się, jak tworzyć niestandardowe banki triggerów i konfiguracje oraz zrozumieć podstawowe ich parametry.

11.1 MODUŁ 1

11.1.1 TRIGGER DETECTION

The function set Trigger Detection hosts two main feature categories:

- Selection of input Channels (Pads)
- Monitoring of Trigger Performance (Peak Monitoring)

Not only the appearance of this module is the same as the **Channel Select** function set in **Kit Editor** → **Moduł 1**, but also its functioning is identical. However, keep in mind that trigger monitors only update in the active mode and won't necessarily display the same color values in the peak row when switching back and forth between Kit editor and Trigger settings.

Before moving on, it is crucial to understand that all functions available in modules 2 and 3 strongly relate to the pad selected under **Input Channels**. Whenever adjustment in these modules seem to have no impact on the trigger performance, you might check if the pad you are playing on matches the selected input channel. The same goes for the selected pad component in module 2.

11.1.1.1 INPUT CHANNELS

The main purpose of the channel select feature is to select connected pads for reasons of assigning different sounds (Kit Editor) or editing their trigger parameters (Trigger Settings). The Pad order from left to right matches the order of **Trigger Inputs** of the rear panel.

Select a connected pad by tapping the button above the pad name. A selected pad is highlighted by a surrounding frame.



G9 Ports – Input Channels



The **Peak** row remembers the highest velocity value detected while playing and for each pad separately. It works in the same way as the peak rows available in other modules and returns the **maximum velocity across all pad components**. Consequently, you are informed about a pad issue when spotting the peak color. The deeper analysis, however, must follow in **Trigger Settings** mode using the **Pad Monitor** (module 4).

In the **Peak** row the velocity scale of 0-127 is translated into color values which depend on the selected UI Theme. Check your UI Theme first to be able to interpret the colors returned under Peak. (*Patrz General Settings → Moduł 4 → Device → UI Theme*)

The following table shows the relation between velocity value, UI theme and color gradients used:

Skale kolorów do wykrywania przesterowań według motywu interfejsu użytkownika

	UI Theme		
Wartość czułości MIDI	GEWA Red GEWA Classic GEWA White Tritanopia	Protanopia Deuteranopia	Grayscale
Peak/Przesterowanie (126-127)			
Normalna czułość (125)			

Czułość niska (1)

11.1.1.2 AUTO SELECT

With Auto Select it is possible to select an input channel by playing the connected pad on one of its components. Turning this feature **[on]** will add the play-to-select feature to the standard select-by-tapping function on the screen. It is recommended to use this feature sparingly, since it can cause confusion when touching other pads accidentally.

11.1.1.3 PEAK DETECTION

With this function you can reset the peak monitor of the active module to the color value assigned to the velocity level of 0. This is especially important to check if altered trigger parameters work as desired. Tapping **[Reset]** refreshes the Peak Monitor and deletes the detection history.

11.2 MODUŁ 2

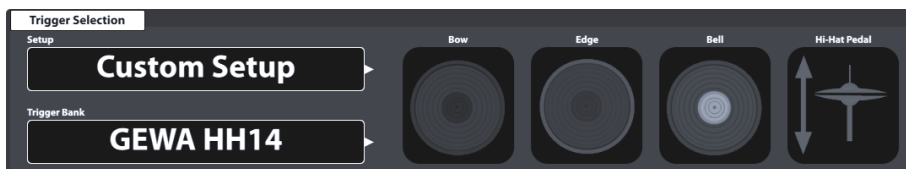

11.2.1 TRIGGER SELECTION

11.2.1.1 SETUP

A collection of trigger banks can be grouped under a setup, which contains all trigger banks assigned to the input channels available. As a result, you can load all trigger banks at the same time by just loading the setup. This is especially useful when experimenting with trigger bank parameters of various pads. This way you can save a setup and switch back and forth between different setups for comparison of trigger the behavior. As in **Effects Mode** it is not mandatory to save edits in parameter values (module 3) as a **Trigger Bank** (module 2). The **direct storage** feature is also available when saving a setup. The trigger bank preset field will show "**Custom Setting**", whose parameter values can still be converted into a preset later. Don't forget to save or create a setup after the creation of a trigger bank, otherwise the setup will recall previous trigger banks when loading it next time. However, since the new trigger bank exists, you can always make up for this by assigning the correct trigger bank preset and saving the setup again.

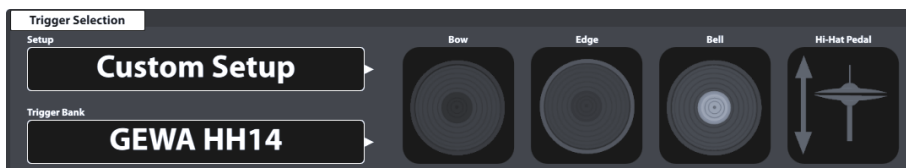

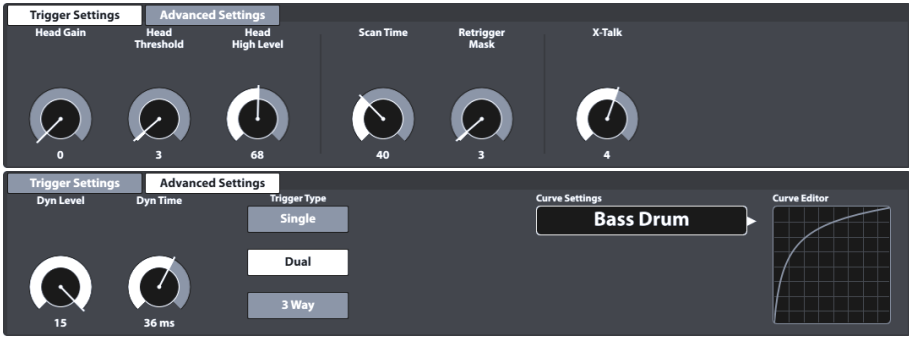

With the Setup on top, the preset hierarchy of the trigger settings parameters is structured as follows:

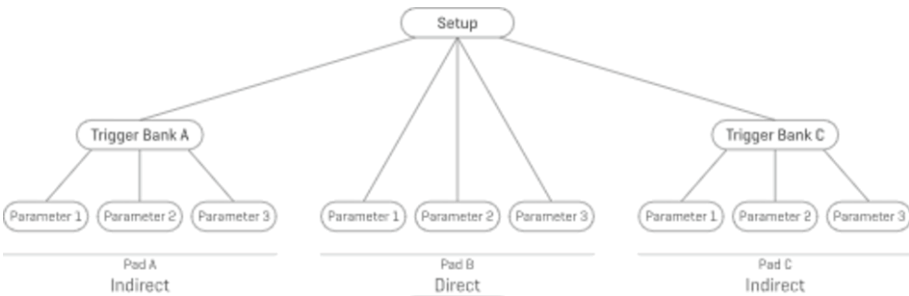

11.2.1.1.1 STANDARD SETUPS

These **Setups** assign default **Trigger Bank** presets to all **Input Channels** available which store parameter values optimized for GEWA pad components and can be found in the **Trigger Bank Selection** browser under **Default Presets**.

The **Standard Setups** are designed to match common GEWA configurations of pads available. Check your configuration and assign the matching Trigger bank for best trigger performance. See the following table how table how each standard setup configures the Input channels with Trigger Banks (Presets):

Factory Setups by GEWA Shell Configuration			
	Setup		
	GEWA STUDIO	GEWA PRO 5	GEWA PRO 6
Input	Trigger Bank	Trigger Bank	Trigger Bank
Kick	GEWA Kick 18inch	GEWA Kick 18inch	GEWA Kick 18inch
Snare	GEWA Snare 12inch	GEWA Snare 14inch	GEWA Snare 14inch
Tom 1	GEWA Pad 10inch	GEWA Tom 10inch	GEWA Tom 10inch
Tom 2	GEWA Pad 10inch	GEWA Tom 12inch	GEWA Tom 12inch
Tom 3	GEWA Pad 12inch	GEWA Tom 14inch	GEWA Tom 12inch

Tom 4	GEWA Pad 12inch	GEWA Tom 14inch	GEWA Tom 14inch
Ride	GEWA Ride 18inch	GEWA Ride 18inch	GEWA Ride 18inch
Hi-Hat	GEWA HH 14inch	GEWA HH 14inch	GEWA HH 14inch
Crash 1	GEWA Crash 14inch	GEWA Crash 14inch	GEWA Crash 14inch
Crash 2	GEWA Crash 14inch	GEWA Crash 14inch	GEWA Crash 14inch
Aux 1	GEWA Tom 10inch	GEWA Tom 10inch	GEWA Tom 10inch
Aux 2	GEWA Tom 10inch	GEWA Tom 10inch	GEWA Tom 10inch
Aux 3	GEWA Tom 10inch	GEWA Tom 10inch	GEWA Tom 10inch
Aux 4	GEWA Tom 10inch	GEWA Tom 10inch	GEWA Tom 10inch
	The default Factory Setup is GEWA STUDIO . If you have purchased a different GEWA Shell configuration, please load the corresponding setup first to ensure the best trigger performance. (Zobacz również sekcję 11.2.1.3.1 Loading Presets na str. 77)		

The setups shown above can also be used as a starting point for customized Hardware setups.

The following sections will guide you through the process of creating new setups. You will also learn how to edit, rename, modify and delete existing presets.

11.2.1.2 TRIGGER BANK

As opposed to the sounds assigned to pad components (Kit Editor), trigger parameter values are not stored directly into the drum kit, but in their own preset, which is independent from any kit. This makes sense, because trigger detection is hardware related and not dependent on any sound parameter. When changing a sound, all trigger parameter values remain the same, since you are still playing the same hardware. For this reason, the whole trigger section works differently from the kit editor, although its appearance is similar.

Trigger banks are stored per input channel (pad), containing all real-time parameter values of each pad component. The difference in conception of **Sound Select** (Kit Editor) and **Trigger Bank** (Trigger settings) figures in the fact that the name in the trigger bank field does not update when tapping on the different component icons of module 2. However, the parameters in **Trigger Settings** → **Moduł 3** will update depending on the active component.

Other than the **Sound Select** field in the kit editor, the trigger bank field is a **preset field**, which adds another step in the hierarchy of parameter value storage. It follows the rules and principles of the G9 preset management system.

11.2.1.3 PRESETS - SETUP AND TRIGGER BANK

The G9 provides a variety of options to manage preset libraries. You can access the library and its functions by tapping on a **Preset Field**. Regarding Trigger Settings, the relevant preset fields for setups and trigger banks are located in module 2. The parameter values stored in these preset fields are derived from module 3. See the following Screenshot for clarification:



The G9 distinguishes between **Factory Presets** (preceding lock icon) and **User Presets** (without lock icon). Both appear in the list that pops up when tapping a preset field. Regarding **Setups**, fields and browsers look as follows:

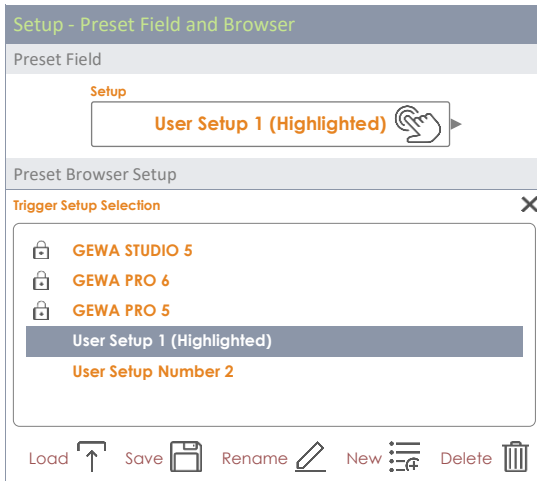

In case of **Trigger Banks**, the corresponding preset browser is structured as follows:

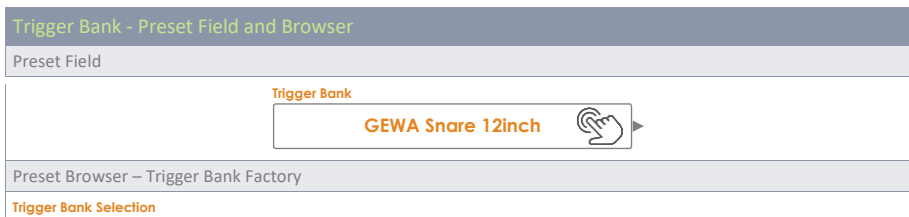





Default Presets		User Presets	
Kicks	Pads	Cymbals	Hi-Hats
GEWA Kick 18inch	GEWA Snare 12inch	GEWA Crash 14inch	GEWA HH14
GEWA Kick Pad	GEWA Snare 14inch	GEWA Ride 18inch	
	GEWA Tom 10inch		
	GEWA Tom 12inch		
	GEWA Tom 14inch		
	GEWA Pad 10inch		
	GEWA Pad 12ich		

Load  New  Feature Shelf

Preset Browser – Trigger Bank User

Trigger Bank Selection ✕

Default Presets		User Presets	
Kicks	Pads	Cymbals	Hi-Hats
My Custom Kick Pad	My Custom Snare		Customized GEWA HH
	My Custom Tom 12in		

Load  Save  Rename  New  Delete  Feature Shelf

At the bottom of each list, you will find all functions applicable for each group of presets, depending on the highlighted entry. Regarding user presets, the palette of options is extended, since factory presets are not editable. Tap on a user preset or factory preset in the preset select dialog for comparison. The following table for gives an overview of the functions available:

Preset Management - Dostępne funkcje					
Kategoria	Funkcje				
	Ściągnij	Zapisz	Nazwij	Nowy	Skasuj
 Presety fabryczne					
Presety użytkownika					

The next sections discuss the functionalities of the feature shelf.

11.2.1.3.1 LOADING PRESETS

Proceed as follows:

1. Tap on the **[Preset]** field.
2. Tap once on the preset you want to load.
3. Tap **[Load]** in the Feature Shelf.

The dialog closes automatically, and the new preset is active.

11.2.1.3.2 SAVING NEW PRESETS

In preparation please check whether the **[Preset]** field contains the name "**Custom Setting**" or "**Custom Setup**". This indicates that values have changed and differ from those stored with the active **Trigger Bank** or **Setup**.



With **Custom Setup/Setting** visible proceed as follows:

1. Tap on the **[Preset]** field.
2. Tap **[New]** in the Feature Shelf.
3. Name your preset using the keyboard.
4. Confirm by tapping **[OK]**.

i Hint: A newly created trigger bank will be added to the preset library only. It is not automatically stored with the active setup. To ensure that the new preset loads with the setup, you will have to store the setup afterwards as well. If not, previous trigger banks will be remembered the next time you load the setup.

11.2.1.3.3 DIRECT STORAGE OF PARAMETER VALUES - SETUPS

The G9 allows for storing parameter values directly into the setup without saving individual presets for trigger banks. Instead of a preset name, the **Trigger bank field** will display "**Custom Setting**". This is the case, when parameter values differ from an existing preset. It is still possible to save custom settings as a preset later and make certain parameter values available for other setups as well.

Two options of direct storage are available:

- a. Overwrite an existing setup
- b. Create a new setup

If you choose direct storage of parameter values proceed as follows:

1. Tap the **[Setup]** field to open the **Trigger Setup Selection** browser.



2. Choose one of the following options:
 - a. Overwrite an existing setup by highlighting a name in the list and tapping **[Save]**.
 - b. Create a new setup by tapping **[New]** in the Feature Shelf, enter a name and confirm by tapping **[OK]**.

11.2.1.3.4 OVERWRITE PRESETS

You can overwrite user presets with current values set in the interface. This function is not available for factory presets (preceding lock icon).

1. Tap the **[Preset]** field.
2. Tap on the preset name to be overwritten.
3. Tap **[Save]** in the Feature Shelf.

11.2.1.3.5 RENAMING PRESETS

Renaming a preset will affect the preset name only and retain individual parameter values. This option is only available for user presets (without preceding lock icon).

1. Tap the **[Preset]** field.
2. Tap once on a preset name in the drop-down list.
3. Tap **[Rename]** in the Feature Shelf.
4. Enter a new name for the preset using the keyboard.
5. Confirm by tapping **[OK]**.

11.2.1.3.6 DELETING USER PRESETS

This function is not available for factory presets (preceding lock icon).

Proceed as follows:

1. Tap the **[Preset]** field.
2. Tap once on a preset name in the drop-down list.
3. Tap **[Delete]** in the Feature Shelf.

11.2.1.4 PAD COMPONENTS

The pad component icons are located on the right-hand side of module 2. You can tap on an icon to activate the component, giving access to its parameters in module 3. The appearance of the icons and their naming depends on the **Trigger Bank** assigned. Assigning a cymbal trigger bank will display *Łuk/Krawędź/Kopułka* (Bow/Bell/Edge) icons and cymbal parameters in module 3, even though the corresponding input channel is labeled as e.g. "Snare". This means in most cases you can convert a pad input channel to a cymbal input and vice versa. However, not all components of the trigger bank might be accessible due to a different hardware design of the channel on the trigger board.

When gaining an understanding of the G9 Trigger Settings, it is important to point out that all function sets and parameters of module 3 always refer to the selected pad under **Input Channels** and its active component (component icon in module 2). By changing either pad or component, parameter values in module 3 will update accordingly. To keep track of your trigger settings, try to



look at this mode as a cascade of Input Channel, Component and Parameters:



11.3 Moduł 3

This module hosts all relevant accessible parameters to fine tune the trigger performance of your pads. Here you can calibrate your G9 to 3rd party equipment and optimize the communication between pads and console.

In case of trigger issues, please start based of the **Setups** and **Trigger Banks** provided and sparingly experiment with the parameters available.

i *Tip: If available, please load provided factory **Trigger Banks** first. Regarding GEWA equipment, the **Standard Setups** assign trigger banks for GEWA equipment to all input channels.*

This section focusses on the explanation of parameters and terms, so that you gain an understanding which parameter to examine when a certain problem occurs.

Finally, when you are happy with the performance, save the parameter values as a preset (Trigger Bank or directly as a Setup). Preset Management regarding Trigger Settings is explained in detail in the previous section (*Zobacz sekcję 11.2.1.3 Presets - Setup and Trigger Bank na str. 75*).

The accessible trigger parameters depend on the component to be adjusted. Therefore, we can compile all parameters in a simple map. In the UI, Parameters are spread over 2 function sets in module 3: **Trigger Settings** and **Advanced Settings**.

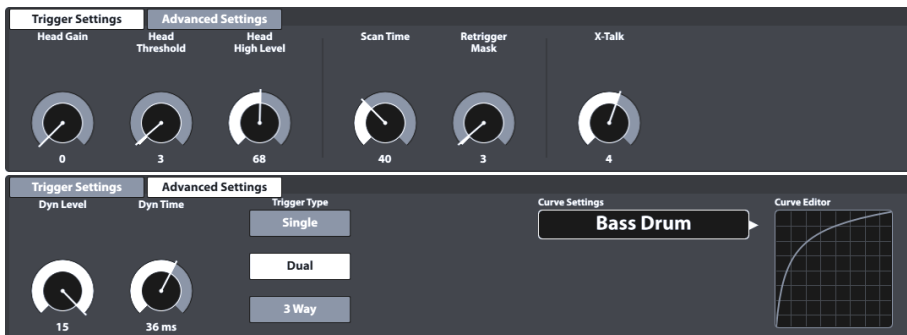

The following table lists all parameters available by component:

Trigger Parameters by Component		
Parameters	Components	
	Drums	Cymbals
	Kick	Other

Parameter Name	Unit	Value Range	Naciąg (Head)	Naciąg (Head)	Obrożec (Rim)	Łuk (Bow)	Krawędź (Edge)	Kopułka (Bell)	HH Controller
Trigger Settings	Gain	Integer	0-8	•	•	•	•	•	
	Threshold	Integer	1-127	•	•	•	•	•	•
	High Level	Integer	8-127	•	•	•	•	•	
	Scan Time	1/10 ms	10-100	•	•	•	•	•	
	Retrigger Mask		1-127	•	•	•	•	•	
	X-Talk		0-7	•	•	•	•	•	
	High Position		0-127						•
	Low Position		0-127						•
	Chick Sensitivity		0-127						•
Advanced Settings	Dyn Time	ms	0-60	•	•	•	•	•	
	Dyn Level		0-15	•	•	•	•	•	
	Splash Sensitivity		0-127						•
	Trigger Type								
	• Single			•	•		•		
	• Dual				•		•		
	• 3Way				Aux 1-3*		Ride*		
	• Piezo					•	•		
	• Switch					•	•		
	Positional Sensing				•				
Velocity Curves (Factory)			•	•	•	•	•	•	
Velocity Curves (Custom)			•	•	•	•	•	•	

* 3Way is a specialty of Roland™ analogue ride cymbals, where bell and other components are separated by their own plug/jack. When using these cymbals choosing the Ride input channel of the G9, Aux 1 will be automatically configured as Bell channel. Optional channels are Aux 1-3, where the following Aux channel is always defined as the bell channel. To this end, the Aux 4 is not suitable, due to the missing bell channel (which should be the non-existing Aux 5).

To gain a deeper understanding on how each parameter affects the detection of trigger signals, the following sections provide explanatory material. We will tackle each parameter following the order of the UI layout.

11.3.1 TRIGGER SETTINGS

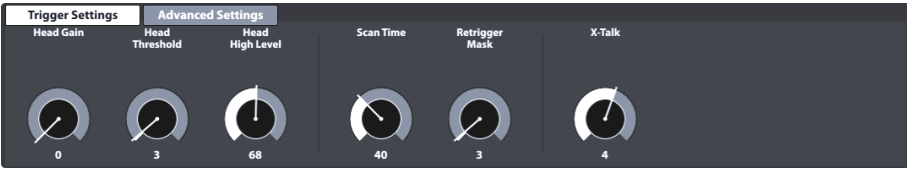

This is the first of the function sets containing trigger parameters. See the following sections for explanations and best practice approaches of each parameter.

11.3.1.1 GAIN

This is simply an amplification of trigger signals received before input. Some piezo ceramic elements available on the markets produce precise, but weak signals, which can be amplified by the gain feature before being recognized as input signal. The construction of the pad used can also contribute to weak signals.

Use this feature, if you are happy with the progression in velocity of your custom-built trigger pad and you feel that the overall volume produced cannot compete with other pads connected to your G9. This feature might come in handy when connecting 3rd party pads from other manufacturers as well.

Gain parameter values range from **0** (no amplification) to **8** (maximum amplification).

Low Gain values are recommended for taming pads producing high electrical signals and higher gain values are suitable for pads producing weaker electrical signals.

The following illustration demonstrates the effect of increasing the gain value given the same velocity progression in the **Pad Monitor** (module 4):

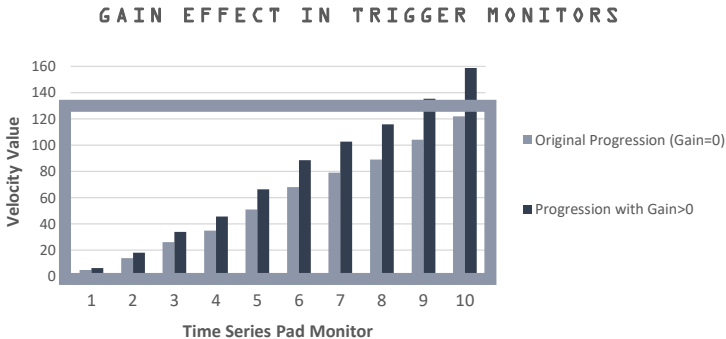

Gain multiplies the signal with a certain factor. Results above the maximum velocity of 127 will cause clipping, losing dynamics in the upper spectrum. Increase the gain slowly, until the response feels natural and the hardest hits produce velocity values of 127. Also keep in mind that it is hard to check dynamics, when the signal is weak. Understand **Gain** always in conjunction with the assigned **trigger curve**. Furthermore, set **High Level** values can produce a bias by compressing the range of input signals mapped to the velocity range of 0-127. The progression should feel like on an acoustic drum, unless you are going for different results.

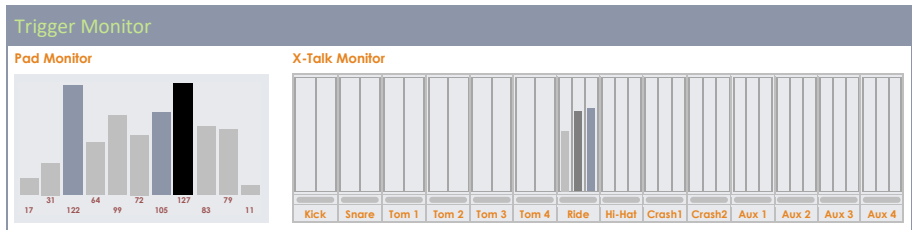

11.3.1.2 THRESHOLD

With this dial you adjust the velocity threshold from which on the G9 accepts signals sent by the detecting sensor (voltage). Low thresholds are preferable for sensitive players, but often cause auto triggering due to vibrations of the environment. Such signals are not desired since they produce sounds which don't stem from striking a pad.

The name threshold is always preceded by the name of the active component and it is available for almost every component, except for Bells (cymbals). Bell and edge sensors work in conjunction with each other and by adjusting the edge sensor, you automatically adjust the bell qualities.

Threshold parameter value range: 1-127

For piezo inputs: Input threshold level. Sets at what minimum (relative electrical) level a signal will be detected as a hit. This is one of the main settings affecting overall performance of the drum kit and the best actual value depends on types of pads used. It may take a while to find the best value.

For switch Obręcze/Krawędź (Rim/Edge) inputs: Input Switch threshold. Sets below which level the switch is detected as hit/pressed. Note that on the switch Obręcze/Krawędź (Rim/Edge) inputs actual velocity is derived from the piezo signal of the Naciąg/Łuk (Head/Bow) input. The best way to set a correct threshold on a switch input is to check the **Pad Monitor for Choke** messages. With a proper threshold value, you should see at least one Choke message when you press the switch. If detected, these Choke Messages appear as black bars with a constant velocity value of 127. Depending on the selected Trigger Type and the way pressure is applied to the sensor, you might observe more Choke messages. If you apply pressure to an FSR Sensor and don't observe Tłumienie (Choke) messages in Pad Monitor, then the Threshold needs to be adjusted. Try to explore the full Threshold spectrum to determine the boundaries between which you obtain Tłumienie (Choke) messages.

Kopułka (Bell) Threshold is relevant for the for the 3rd zone of a 3 Zone Yamaha-style pad/cymbal. Sets below which level the Kopułka (Bell) switch is detected as hit/pressed. This level must be lower than the Threshold level of the obręcze/krawędź input of a switch type trigger (**Krawędź (Edge) Threshold**). If the connected pad is a 3Way Roland cymbal, **Kopułka (Bell) Threshold** must be set to 0 to prevent false triggering of Bell notes.

How to proceed:

Strike components detected by piezo elements (e. g. Naciąg (Head)) as soft as you would normally play and start with the lowest threshold, rising it gradually until your softest strokes are not recognized in the **Trigger Monitor** any more. Then go back 1-2 steps in threshold again. This way you set the threshold as low as possible and as high as needed. Regarding **Switch** inputs the procedure works the other way around. Since Switch type sensors already carry a low voltage permanently, the voltage goes down by pressing/activating the sensor. Increase the threshold gradually and select the highest threshold that still returns choke messages in **Pad Monitor**.

11.3.1.3 HIGH LEVEL

High (top) level of the input. In conjunction with the **Threshold** it sets the boundaries of the span of relative electrical signals to which the MIDI velocity value range (0-127) is mapped. Signals with relative electrical levels between Threshold and High Level will produce MIDI notes with velocities between 1 and 127. Any signals with relative electrical levels above **High Level** will produce MIDI notes with velocity 127. The further Threshold and High Level are apart the better, provided you can reliably get MIDI notes with velocity 127 for the strongest hits. Having said that, you will lose almost no dynamics until when **High Level-Threshold<25~38**. If you set High Level to maximum (127), and still easily get MIDI notes with velocity 127 you probably have a very 'hot' pad and you may lose hit dynamics. Try lowering **Gain**. If it doesn't help you will probably need to use a voltage divider on the input.

G9 High Level parameter value range: 8-127



***Hint:** The High Level value range of the G9 translates relative electrical signals into the MIDI Value range (0-127). Don't confuse this range with MIDI velocity. Depending on the strength of signals a pad produces it is possible to lower High Level below 127 and still reach velocities of 127.*

11.3.1.4 SCAN TIME

Minimum scan time for the input. Measured/shown in 1/10th of millisecond. Can be set between 10 and 100 (1 - 10ms). When the G9 detects a signal above **Threshold**/Dynamic threshold, it will keep sampling it for the length of the set **Scan Time** Period before marking the signal as registered and making it ready to be sent via MIDI. Next, the G9 scans all Trigger Inputs for registered signals again.

The exact system latency (from stroke to sound) consists of the delay from sensor to input, 1 fixed millisecond for a non-editable Latency parameter (analysis trigger signals), the **Scan Time** parameter and the time for the resulting MIDI message to produce the sound in the sound engine. **Scan Time** and Latency describe the boundaries of minimum and maximum latency in trigger performance as follows: G9 trigger latency is at least Latency(1ms) and maximally Latency (1ms) + **Scan Time**.

Lowering **Scan Time** will improve latency and may worsen level accuracy. Raising it will worsen latency and may improve level accuracy.

Generally, for rubber type pads/cymbals setting Scan Time to 20 (2ms) is enough for proper signal level detection. For mesh-type pads you may need to raise Scan Time to 30-50 - the bigger mesh type pads the higher **Scan Time** is required for proper signal level detection.

Scan Time parameter value range: 10-100

11.3.1.5 RETRIGGER MASK

Retrigger period in milliseconds for the input. Determines how many milliseconds must pass after a previously detected signal for a new signal to be detected - to prevent a 'machine gun' effect or false triggering due to vibration after a hit. As a threshold setting this is one of the most important parameters and it may take some time to find the best value. Ideally it should be set as low as possible and let **Threshold** combat the 'machine gun' side effect as well as false triggering in first place. But if even with highest **Threshold** Levels and dynamic threshold decay times (**Dyn Time**) you still get these unwanted effects; you may need to raise the **Retrigger Mask** level. On **DIY** pads and cymbals, good Retrigger Mask values are in the range of approximately 4 to 12 milliseconds. Setting Retrigger Mask too high will prevent you from doing fast drum rolls.

Retrigger Mask parameter value range: 1-127

11.3.1.6 X-TALK

X-Talk is a tool to avoid triggering of unwanted signals caused by other pads in the immediate vicinity. When instruments are mounted on a rack or stands which have physical contact, playing on one instrument can cause shock-like vibrations. As a result, trigger sensors are activated in a more aggressive way than the impact of natural sonic waves would have on surrounding acoustic instruments. Consequently, surrounding instruments respond with sound whose volume is unnaturally high.

X-Talk allows you to set a **Threshold** for other triggers to respond to strokes on a certain pad, while velocity values below the set threshold are simply ignored by the analyzing unit (G9 Module). However, this practice comes at a price, since the physical impact of two instruments on each other is mostly mutual. High **X-Talk** thresholds work against low activation thresholds of individual pads (sensitive players) and any physical issue often requires rising the **X-Talk** values on both instruments causing the problem. Check your hardware first and try to avoid physical contact as much as possible before making use of the **X-Talk** feature.

X-Talk Parameter Value Range: 0-7

See the following section on how to work with **X-Talk**.

11.3.1.6.1 ADJUSTING X-TALK PARAMETERS

If despite the best possible hardware setup, a pad is activated by others, try to identify the source pad, sending unwanted MIDI signals using the **X-Talk Monitor**. Then raise the X-Talk value to at least one (1) on **both** pads (emitting pad and receiving pad). If the problem still occurs, raise the value gradually on the pad which receives unwanted signals. It is important that both pads have X-Talk values of at least one to make them a member of the X-talk group. High X-talk values on the pad experiencing disturbance will have no effect, if there is not at least one other connected pad with an X-talk value of at least 1. Only keep raising x-talk values on pads experiencing problems. The goal is: as low as possible, and only as high as required to suppress viral MIDI signals.

11.3.1.7 HIGH POSITION (HI-HAT PEDAL ONLY)

Set the High Position of the Hi-Hat Pedal, when pedal is fully open (released). If set too high you may not be able to access the Sound Sample Layers for fully opened Hi-Hat Cymbals, even if the Cymbals are spaced apart completely (resting position).

Ideally you adjust **Low Position** and **High Position** in a way that the values are as far apart as possible and yet pedal/controller reach extreme positions. Use the VU Meter **Pedal Position** (not very accurate) or CC messages visible in **Pad Monitor**. When using Pad Monitor CC messages as a guidance you need to achieve such a configuration that CC messages are not sent by the G9 in extreme pedal positions.

High Position Parameter Value Range: 0-127

11.3.1.8 LOW POSITION (HI-HAT PEDAL ONLY)

Set the low level of the pedal, when pedal is fully pressed, and the cymbals are in closed position. This corresponds to the lowest position the controller shaft will reach. If **Low Position** is set too low you

may not be able to get fully closed Hi-Hat Sounds, even if the cymbals are in closed position with a good amount of pressure on the Hi-Hat Pedal.

Low Position Parameter Value Range: 0-127

11.3.1.9 CHICK SENSITIVITY (HI-HAT PEDAL ONLY)

Measured against CC MIDI message value: 0 - for fully open, 127 - for fully closed. Set the level below which a following pedal 'step on' will generate a chick.

Chick Sensitivity Parameter Value Range: 0-127

11.3.1.10 KALIBRACJA PEDAŁU (HI-HAT)

Ta funkcja ustawia wartości dla **pozycji niskiej** i **pozycji wysokiej** za pomocą kreatora kalibracji. Zamiast wypróbować różne wartości indywidualnie, ten proces będzie szczególnie przydatny w połączeniu ze sprzętem innych firm, zapewniając dobrą ocenę szacunkową zakresu wartości. Ponieważ pozycja dolna odnosi się do pozycji zamkniętej przy maksymalnym docięnięciu i ograniczonym zastosowaniu muzycznym, procedura automatycznie określi pozycję zamkniętą i zwiększy ją o 15% powyżej określonej wartości dolnej pozycji. Po kalibracji mogą być konieczne drobne ręczne regulacje parametru Low Position, aby skompensować charakterystykę pracy Hi-Hatu.

Poniższa tabela wyjaśnia działanie kreatora kalibracji:

G9 Hi-Hat Calibration

Grafika

Porady

1



Naciśnij ikonę pedału Hi-Hat w module 2, aby wybrać kontroler / pedał Hi-Hat.

2



Naciśnij **[Calibrate...]** w module 3

3



Hi-Hat Calibration

High Position
109

Low position
90

W tym oknie dialogowym można skalibrować parametry Niska pozycja i Wysoka pozycja pedału Hi-Hat.

Postępuj zgodnie z instrukcjami krok po kroku.

Naciśnij **[Next]** aby rozpocząć kalibrację.



Cancel



Next

Ekran startowy z krótkim objaśnieniem
Naciśnij **[Next]** aby rozpocząć kalibrację.

4



Hi-Hat Calibration

High Position
109

Low position
90

Niska pozycja

Naciśnij pedał do końca i naciśnij **[Calibrate]**.

Następnie naciśnij **[Next]**.



Cancel



Next

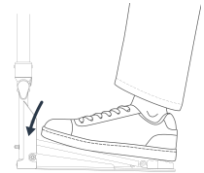

Zastosuj **MOCNY** nacisk (pozwoli to na pełną kontrolę Hi-Hatu) przed naciśnięciem **[Calibrate]**

5

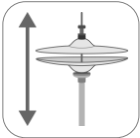

Hi-Hat Calibration

High Position
109

Low position
84

Wysoka pozycja

Zwolnij całkowicie pedał i naciśnij **[Calibrate]**.

Następnie naciśnij **[Finish]**.



Cancel



Finish

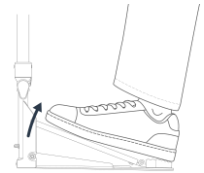

Zdejmij nogę całkowicie przed naciśnięciem **[Calibrate]**

11.3.2 ADVANCED SETTINGS

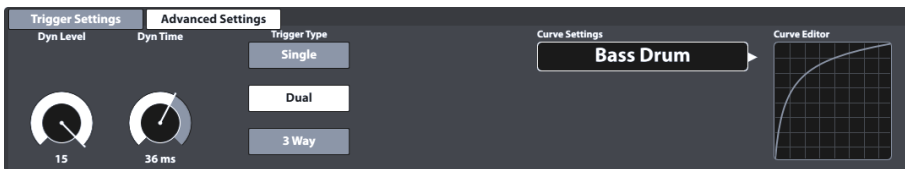

This is the second of the function sets containing trigger parameters. See the following sections for explanations and best practice approaches of each parameter.

11.3.2.1 DYN LEVEL & DYN TIME

Dynamic Threshold level and Dynamic Threshold decay time for the input. Also, two very important parameters. Raising both **Dyn Level** and **Dyn Time** will tell G9 to suppress false triggering harder (crosstalk between inputs and double triggering). Raising them too high may cause the G9 to miss some hits on fast/press rolls. **Dyn Level** sets how hard the G9 will try to suppress false triggering. **Dyn Time** sets for how long false triggering will be suppressed. For most rubber type pads/cymbals **Dyn Level** between 8 and 15 and **Dyn Time** between 8 and 20 should produce the best results. For mesh type pads it may be necessary to raise **Dyn Time** above 20 and up to 60. The bigger the Mesh Head diameter, the higher **Dyn Time** values are required.

GEWA Trigger Trays by design should produce best press rolls with **Dyn Time** values between 8 and 10.

Dyn Level parameter value range: 0-15

Dyn Time parameter value range: 0-60 ms

11.3.2.2 SPLASH SENSITIVITY (HI-HAT PEDAL ONLY)

Sets the number of milliseconds the G9 will wait before sending a **slash note**, when you execute a **splash**. It can be set to any value above 0. If you set it to 0 you can only get **Chicks** (splash is off). The higher the **Splash Sensitivity** the easier it is to get "splashes" but the longer are the delays for their detection. If set it too high (15-30 milliseconds) you might begin noticing **splash latency**.

Splash Sensitivity parameter value range: 0-127

11.3.2.3 TYPÓW TRIGGERÓW (TRIGGER TYPE)

The trigger type allows for communication with various types of pads of different manufacturers. The options available vary with the selected component. Not all combinations are possible. In case of "Single" settings for Obręcz/Krawędź (Rim/Edge) and Kopałka (Bell) will be ignored.

Triggerów typ (Trigger Type) by Component

Naciąg/Luk (Head/Bow)	Obręcz (Rim)	Krawędź (Edge)
Single	Piezo	Switch
Dual (Default GEWA)	Switch	
3Way (GEWA option)		

Single:

Naciąg/Łuk (Head/Bow) and Obręcz/Krawędź (Rim/Edge) are treated as two different pads. An application would be a simple single zone pad with single piezo triggering.

Dual:

Sets the Naciąg/Łuk (Head/Bow) Channel up in a way that Obręcz/Krawędź (Rim/Edge) signals are expected to use the same Input Channel as Naciąg/Łuk (Head/Bow). In combination with this choice you must also specify, how the Obręcz/Krawędź (Rim/Edge) signals are detected (Piezo or Switch). Change to the other components by tapping on the component icons and check your settings for every input channel.

All GEWA pads work as **Dual** pads with **Piezo** detection for **Obręcze (Rims)** and **Switch** for **Krawędź (Edge)** and **Kopułka (Bell)**.

The latter is set to switch automatically and activates as soon as you assign a cymbal trigger bank to an input channel and chose Dual for Łuk (Bow) and Switch for the Krawędź (Edge).

3Way:

This is a specialty regarding cymbals. Some manufacturers separate the Kopułka (Bell) channel from the rest, allowing for an individual velocity curve on Bells. GEWA cymbals support both methods (Dual and 3Way). Select 3Way for Łuk (Bow) components and switch for the Krawędź (Edge) component. As a result, the Kopułka (Bell) will be configured "Switch" automatically and the input channel next to the Łuk/Krawędź (Bow/Edge) input channel will be reserved for the Kopułka (Bell). Connect this jack with a 1/4" TRS cable to the outer jack of your GEWA Cymbal. For further information on connecting cymbals and all possible pairs of input channels using 3Way, [Zobacz sekcję 3.2.3 Talerze na str. 9.](#)

Piezo and Switch:

These options are available for Obręcz/Krawędź/Kopułka (Rim/Edge/Bell) components only and follow the type of trigger used. For pads with 2 Piezos for triggering Head and Rim, choose **Dual** for the **Naciąg (Head)** and **Piezo** for the **Obręcze (Rim)**. Cymbals mostly utilize an FSR film for the detection of Kopułka/Krawędź (Bell/Edge) and Tłumienie Talerza (Choke). Choose **Switch** for the Krawędź (Edge) component, while the **Łuk (Bow)** can either be set to **Dual** or **3Way**.

11.3.2.4 CURVE SETTINGS

Even if the sound samples of consecutive velocity layers are recorded in a linear fashion, most contemporary trigger methods follow a concave progression in detection of signals. This means that even if you increase the velocity of a stroke linearly, the trigger method will return a velocity value that follows a non-linear path. This skew in detection needs to be corrected, so that the software picks a set of sound samples which matches the intensity of stroke in real world. To this end, the G9 ships with a limited number of curves representing different degrees of detection skews. Choosing adequate velocity curves depends on the choice of components of different manufacturers (technical specifications) and the personal expectations in sound progression of the player. The **Presets** provided are curves optimized for pads using the GEWA Trigger Trays and Cymbals and the preset curves provided already compensate this effect to a certain degree, so that they appear less bend in the Interface, maximizing the possibilities of customization. Not only does the standard curve have a linear appearance, it is also designed to return a linear feel in audible dynamics. The following section tackles the assignment of preset curves.

11.3.2.4.1 ASSIGNING PRESET CURVES

Proceed as follows:

1. Select an **Input Channel** in Module 1 (Pad).

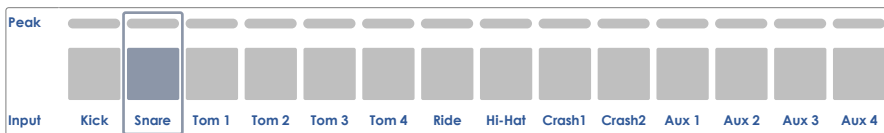

2. Select a component to edit by tapping the corresponding icon in module 2 (Trigger Selection).



3. Tap the function set **Advanced Settings** in module 3.
4. Tap once on the **[Curve Settings]** field.



5. Select one of the curves in the **Presets** or **User** column by double tapping.

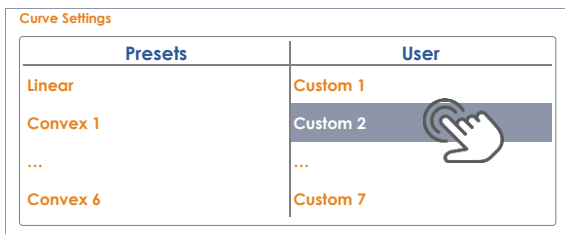

6. Save your changes by doing one of the following:

- a. Directly in a **Trigger Set Up**:
 - i. Tap the **Setup** field (module 2).



- ii. Highlight a user Setup where you want to store the curve and tap **[Save]**. Alternatively tap **[New]** in the Feature Shelf to create a fresh Setup.





- b. As a **Trigger Bank** (Preset indirect):
 - i. Tap the **Trigger Bank** field (module 2).



- ii. Select a User Trigger Bank in the drop-down list and tap **[Save]** to overwrite the highlighted entry. Alternatively tap **[New]** to create a new Trigger Bank with current parameter values visible in the User Interface.



The following table shows the drop-down list which opens by tapping the **Curve Settings** field:

Curve Settings	
Presets	User (Editable)
Linear	Custom 1
Convex 1	Custom 2
Convex 2	Custom 3
Convex 3	Custom 4
Convex 4	Custom 5
Convex 5	Custom 6
Convex 6	Custom 7
Concave 1	

Concave 2

Note: Trigger curves work on a pad component level. Assigning a new curve will only affect the active component (Naciąg (Head), Obręcz (Rim), etc.) in module 2 of the selected pad under input channels (module 1). Make sure that the correct pad component is activated (tap on its icon) and repeat the process for the remaining components if necessary. If you can't find a curve among the preset curves provided that satisfies your expectations, you have the option of design **up to 7 custom curves**. For more information please refer to the following section.

11.3.2.5 CURVE EDITOR

Next to the preset curves you can create and fine tune your custom trigger curves. These curves are specific to the component selected (e.g. Kopułka (Bell) or Naciąg (Head)). That means you can adjust the velocity curve of components independently from each other. The choice of the curve type depends on how voltage generated by the sensor progresses with the velocity of the stroke. With this feature, the G9 allows for compensation of different trigger detection methods and sensor types from various manufacturers.

In the acoustic world the relation between volume and velocity of strokes is typically linear, but the relation between the voltage generated by the sensor depending on the stroke velocity is typically concave. That means that without any compensation, the trigger board would constantly address Sample Layers from the sound bank that were recorded at lower stroke velocities.

Soft strokes would sound unnaturally quiet with an unnaturally low increase in volume while executing a **crescendo**. The function of a hull curve is simply to offset the errors caused by the sensor and bring the detection of signals in harmony with the acoustic world, so that those sample layers are drawn from the sound bank that match the intensity of the stroke.

With this knowledge we know, that an adequate compensation of detection skews must be typically convex, although the real characteristics of a certain sensor are unknown. Even the way how a piezo is attached to the hardware can alter the detection curve drastically. Therefore, finding the perfect compensation curve is always a matter of trial and error.

The following section guides you through a typical process of creating custom curves in the G9.

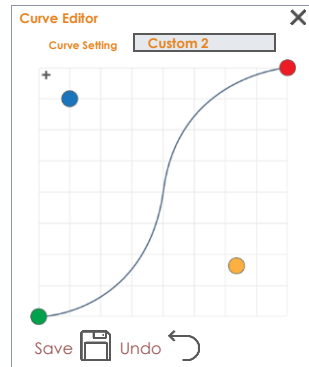

11.3.2.5.1 CREATING CUSTOM CURVES

1. Select an **Input Channel** in Module 1 (Pad).



2. Select a component to edit by tapping the corresponding icon in module 2 (**Trigger Selection**).



- In the the function set **Advanced Settings** (Module 3) tap once the **[Curve Settings]** field.



- Select one of the curves in the **User** Presets column by double tapping.

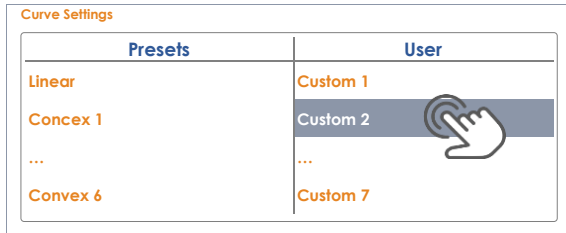

- Tap the field **[Curve Editor]** once in the function set **Advanced Settings**.



- Edit the curve by dragging the dots and check effects by playing on the pad component.

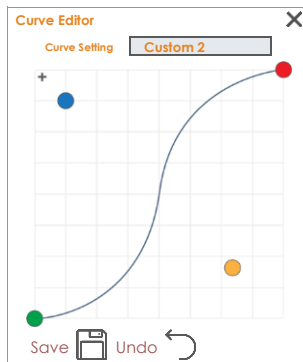

- (Optional) Add/remove another control point by tapping **[+]**.
- (Optional) Rename the curve by tapping the field **[Curve Setting]** to open the keyboard.
- Tap **[Save]** in the Curve Editor to store the new curve shape.
- The curve itself is a preset which will only take effect if it is assigned to a trigger bank preset or setup. Curves that are already assigned to higher trigger preset orders will update in trigger banks and setups immediately after saving the curve shape (step 9). In this case the following steps are optional. Proceed as follows:

- a. Storage directly in a Trigger Setup:
 - i. Tap the **[Setup]** field (module 2).
 - ii. Highlight a user setup tapping once on the list entry and Tap **[Save]** in the Feature Shelf to update the setup. Alternatively tap **[New]** to create a fresh setup for your pad configuration.



- b. Storage as Trigger Bank (indirect):
 - i. Tap the **[Trigger Bank]** field (module 2).
 - ii. Highlight a User Trigger Bank by tapping once on the list entry and tap **[Save]** to update the Trigger Bank. Alternatively tap **[New]** to create a fresh **Trigger Bank** for your pad.



i **Hint:** Modifying, renaming and saving already assigned user curves will not result in a "Custom Setting" in the Trigger Bank field. Instead, the trigger bank name is retained, and saved changes in curve shapes will update accordingly in every setup or trigger bank the curve is assigned to. In this case you don't need to save the trigger bank separately.

i **Note:** Only custom trigger curves are editable!

Useful functions of the curve editor dialog:

Curve Editor – Feature Shelf	
	Undo (Returns to the initial curve shape before opening the Curve Editor)
	Save (Saves the curve points as seen in the UI)

11.4 MODUŁ 4

11.4.1 TRIGGER MONITOR

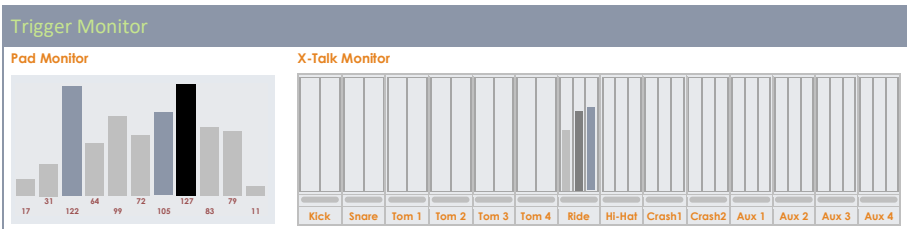

In this module you will find all visual monitors tracking the input signals of each pad component. Results are mostly visualized by colors, which change depending on the active **UI Theme** (check **General Settings** → **Moduł 4** → **Device** → **UI Theme**).

Color schemes for Trigger Monitors are chosen as follows:

Colors Trigger Monitor by UI Theme					
		Naciąg łuk (Head Bow)	Obrożce Krawędź (Rim Edge)	Kopułka (Bell)	Tłumienie (Choke)
UI Theme	GEWA Red GEWA Classic GEWA White Tritanopia				
	Deuteranopia Protanopia				
	Grayscale		White		

See the following sections to learn about the functioning of each monitor, so that you can interpret them.

11.4.1.1 PAD MONITOR

Monitors all registered signals of the **Input Channels** by returning the stroke velocity in the standard MIDI range of 1 to 127. A time series of the last 10 strokes is displayed in the viewport. Detected head strokes and rim strokes are distinguished by the color of the bars and depend on the **UI Theme** chosen. See the color table in the previous section for reference. The actual velocity value of a stroke is shown at the bottom of each peak and visualized by the height of the bar.

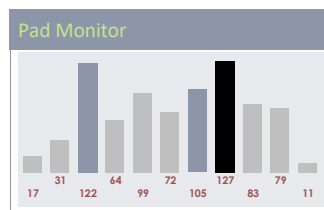

The pad monitor is useful for detecting whether a pad is maxing out at moderate strokes already, or a pad is causing barely audible double triggering.

To sum it up, the pad monitor gives valuable real-time feedback about the communication between the G9 and its connected pads.

11.4.1.2 X-TALK MONITOR

The Crosstalk Monitor detects every signal of each pad sent to the G9 while playing. Its main purpose is to observe trigger signals sent by pad components you haven't hit at all. Often vibrations

travel through the hardware and cause accidental activation of other sensors (X-Talk). Striking a certain component should only activate the sensor responsible for that very component. Check your hardware set up, if you activate more channels or components, than those you are playing. As opposed to the Pad Monitor, the X-Talk Monitor gives feedback about the last stroke only. Apart from peak meters for components, the X-Talk Monitor tracks the highest peak of an input channel while playing, represented by a fine bar between pad name (input channel) and peak meters. Examine your trigger settings in case of these bars lighting up in peak colors although you are playing moderately. Maximum peaks are visible for about 5 seconds after the last detected input signal. After this period, the X-Talk Monitor clears all values, resulting in a blank monitor screen.

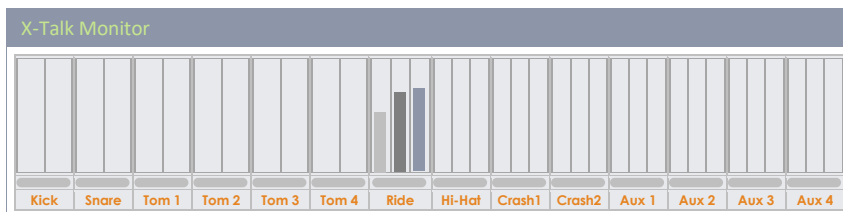

12 OGÓLNE USTAWIENIA (GENERAL SETTINGS)



Wszystkie zmiany dokonane w tym trybie wpływają na parametry pracy urządzenia i są przechowywane globalnie i zapamiętywane przy następnym uruchomieniu.

Tutaj znajdziesz więcej opcji, takich jak **sterowanie wyjść głównych (Master outs)**, **wyjść bezpośrednich (Direct Outs)** i **wyjść cyfrowych (Digital Outs)**, w tym equalizerów i kompresorów. Możesz także kontrolować **trasowanie padów (Routing Drums)** i **trasowanie innych sygnałów wejściowych (Routing Others)**. Routing to bardzo potężne narzędzie, które umożliwi wysyłanie dowolnego sygnału wejściowego do dowolnego wybranego kanału wyjściowego, od słuchawek po standardowe DAW, takie jak Cubase, Pro Tools i Logic Pro. Kontroluj dźwięk samodzielnie i wysyłaj wybrane sygnały do audio za pomocą **macierzy routingu**.

Ponadto można przypisać zewnętrzne elementy sterujące, takie jak przełączniki nożne lub pady, do wyzwalania określonych zdarzeń w interfejsie. Moduł 3 zarządza wszystkim co jest związanym z implementacją MIDI, podczas gdy moduł 4 urządzenia ma specyficzne funkcje, takie jak Bluetooth i Wi-Fi. Moduł ten służy także w celu aktualizacji oprogramowania, resetowania fabrycznego i pobierania instrukcji bez konieczności odwiedzania zewnętrznych stron internetowych.

12.1 MODUŁ 1

This module controls global properties for all standard outputs offered by the G9 Workstation. Next to exclusively stereo outputs like **Master Outs** you can manage **Direct Outs**, which function as Dual Mono or Stereo depending on your choice. On the other hand, the function set **Digital Outs** provides controls for the amplification or reduction of digital audio signals. The activity of each output is monitored via the corresponding peak meters. Peak meters are activated by playing on pads, playing a song via Bluetooth or Song Player if these inputs are assigned to the output of interest in the **Routing Matrix**. Check the tabs **[Routing Drums]** and **[Routing Others]** to see whether the nodes are checked for a pair of Input and Output.

12.1.1 MASTER OUTS



This function set provides adjustments for the standard outputs of the console such as **Master Outs** (XLR, S/PDIF), **Monitor Outs** or **Phones**. The volume dials are instances of the corresponding hardware dials on the left-hand side. Consequently, values of the hardware dials will update when adjusting the volume of an output in **Master Outs**. The **Balance** dials however can only be found in this location, allowing for correcting acoustic properties of the environment or connected hardware. L/R Buttons in this function set have only informative character. As mentioned above, these outputs are exclusively stereo.

The following tables show the ports addressed by the adjustments made in this function set:

Ports – Master Out



XLR – L (analog)



XLR – R (analog)



S/PDIF – Stereo (digital)

Ports – Monitor Out



1/4" (6,35 mm) TS – L (Mono)



1/4" (6,35 mm) TS – R (Mono)

Ports – Phones (Front Panel)



1/4" (6,35 mm) TRS – Stereo

12.1.2 DIRECT OUTS

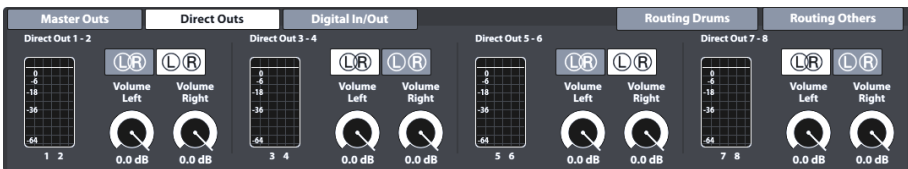

Adjustments of **Direct Outs** work in the same way as **Master Outs**, but with the exception that **Direct Outs** can be configured as either **Dual Mono** outputs or **Stereo** outputs. The choice in configuration will take effect in the routing matrix **Routing Drums** ([Zobacz sekcję 12.1.4 Routing Drums & Routing Others na str. 99](#)).

To be able to handle Dual Mono configurations, the 8 individual Mono Outs are arranged in groups of two (**1 - 2, 3 - 4, 5 - 6, 7 - 8**). A second L/R icon is added to each group. In Direct Outs L/R icons are interactive and function as buttons to switch between Dual Mono and Stereo configuration. Icons and their meaning:

Direct Outs - Configurations	
	Stereo Configuration
	Dual Mono Configuration

In the Dual Mono world balance dials are obsolete, therefore volume and balance dials are replaced by two individual volume dials (**Volume Left, Volume Right**). This allows for independent volume adjustments in Dual Mono settings, while in a Stereo configuration you can balance out left and right speakers by tweaking values of the individual volume dials in relation to each other.

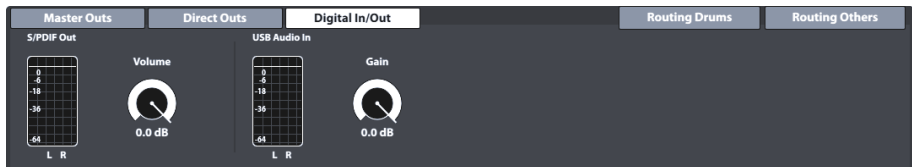

Ports – Direct Outs (Rear Panel)	
	1/4" (6,35 mm) TS (Mono)

12.1.3 DIGITAL IN/OUT



This function set controls the volume of the digital audio connections. Note that USB Audio can be used next to the occupation of the USB port as MIDI. Audio and MIDI Data can flow at the same time. The logarithmic faders allow for digital attenuation of signals within a range between $-\infty$ dB (max) to 0 dB (min).

See the following table for ports addressed by the adjustments in this Function Set:

Ports – Digital In/Out	
	S/PDIF – Stereo Output (digital)
	USB-MIDI – Bidirectional (In + Out), USB Audio In

12.1.4 ROUTING DRUMS & ROUTING OTHERS

You can send any input signal to a variety of output channels built into the G9 by utilizing the **Routing Matrix**. In this section you will learn how to edit, save, load, rename and delete matrix layouts. This is very useful if you are working in several studios or venues. Once you return to a studio or mixing desk, you can adapt your G9 to the given circumstances in just a few taps and recall the work settings stored before.

The G9's routing function is divided into 2 input categories: **Routing Drums** and **Routing Others**. While their routable channels vary, the functionality and appearance are the same. Thus, the contents of the following subchapters apply to both input categories likewise.

Tap the routing buttons in the upper right corner of module 1 to open the corresponding **Routing Matrix**:

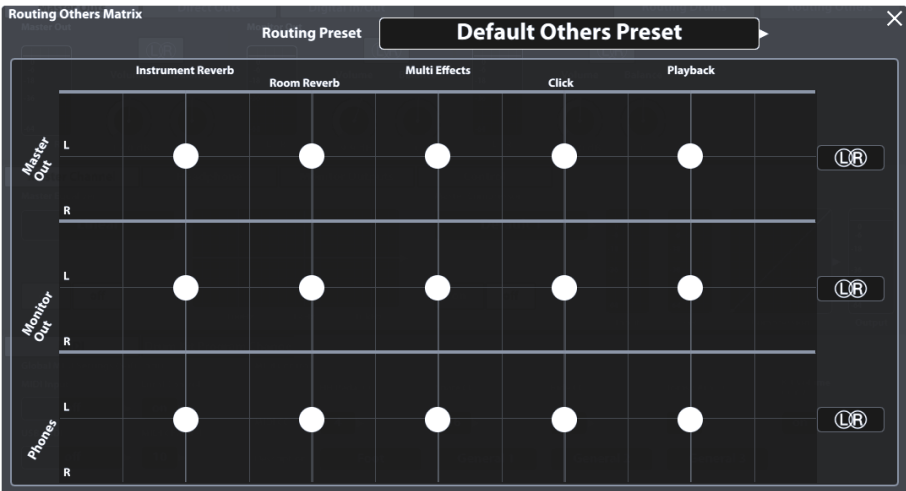
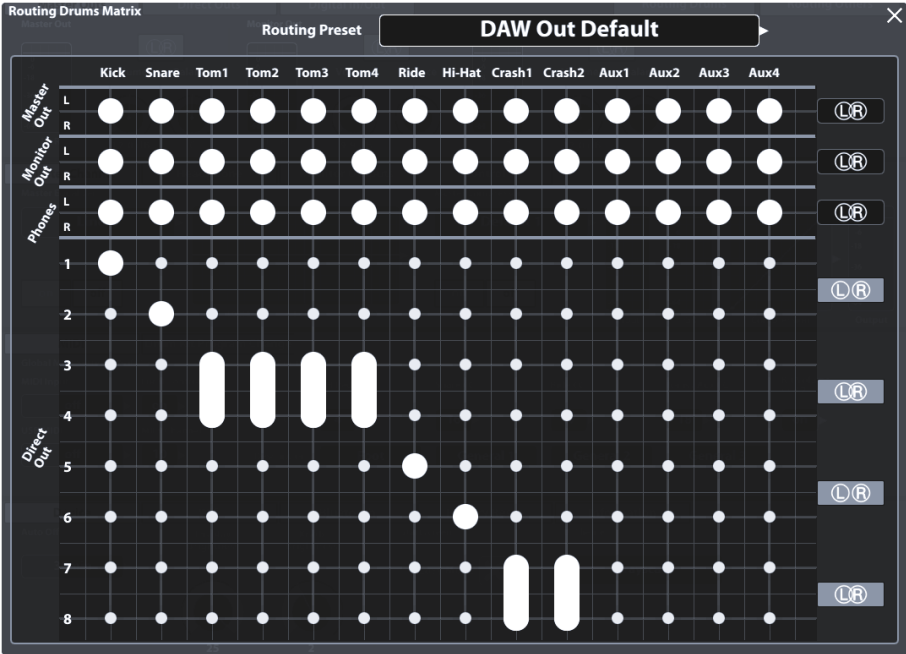

12.1.4.1 EDITING THE ROUTING MATRIX

1. Tap on **[Routing Drums]** or **[Routing Others]** to open the corresponding Routing Matrix.

Note that the **Input Channels**, effects and routable sound sources (Pads in particular) are arranged horizontally (Columns), whereas the available **Output Channels** are arranged vertically (Rows). Big dots indicate in which output an Input channel is audible and small dots show channels which are muted in the Mix sent to an output.

2. **Remove** an input channel from an output by tapping the big dot at the point of intersection of input column and output row.
3. **Add** an input to an output channel by tapping the small dot at the point of intersection of input column and output row.

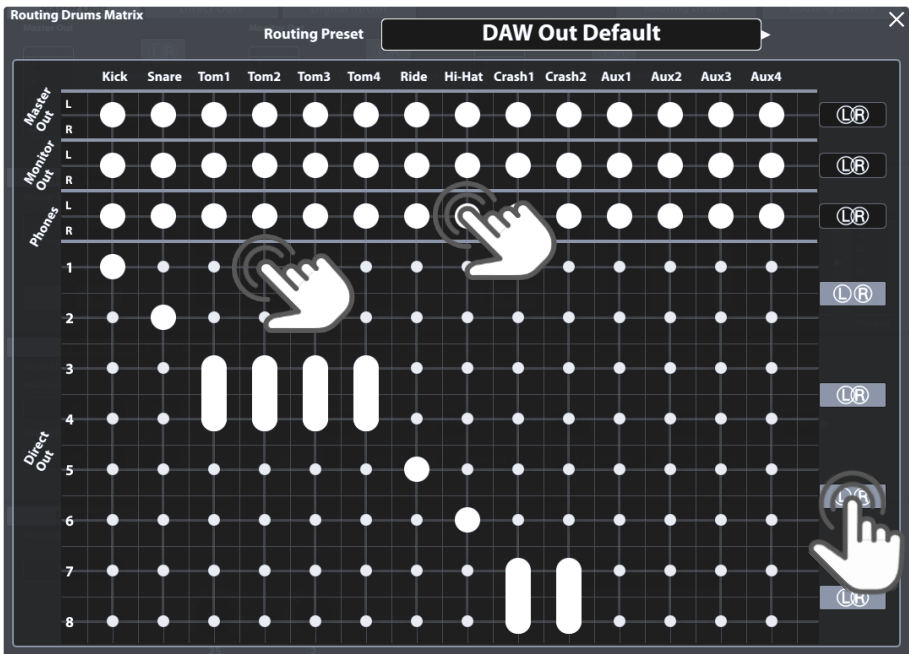

Direct Outs (Routing Drums) are special in a way that you can bind them together to a stereo output. Instead of 8 Mono outputs, you have the option of at most 4 stereo outputs. The L/R icons on the right-hand side of the routing matrix inform you about the current state. Intersection of the circles stands for stereo, whereas circles without intersection indicate a Mono configuration. A thick line will be drawn between the dots when adding an input channel to combined **Direct Outs** (stereo). L/R icons for direct outs are switchable in the routing matrix, too. Change mono/stereo settings of the Direct Outs by simply tapping the according buttons in the routing matrix, or:

1. Close the Routing Matrix and go to **General Settings** → **Moduł 1** → **Direct Outs**.

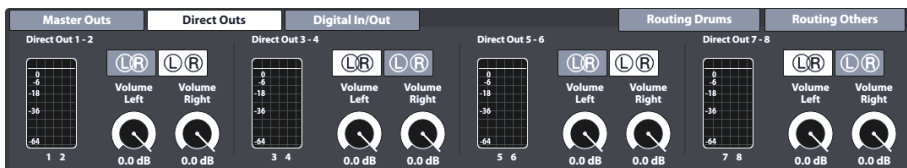

2. Switch between the L/R icons by tapping on the corresponding button.
3. Open the Routing Matrix again and check the state of the L/R icons on the right-hand side.

Direct Outs - Configurations

Stereo Configuration

Dual Mono Configuration

12.1.4.2 PRESETS – ROUTING

The G9 provides a variety of options to manage preset libraries. You can access the library and its functions by tapping on a **[Preset]** field next to a group of preset parameters. In the drop down, that open by tapping on a preset field, the G9 differentiates between **Factory Presets** (preceding lock icon) and **User Presets** (without lock icon).

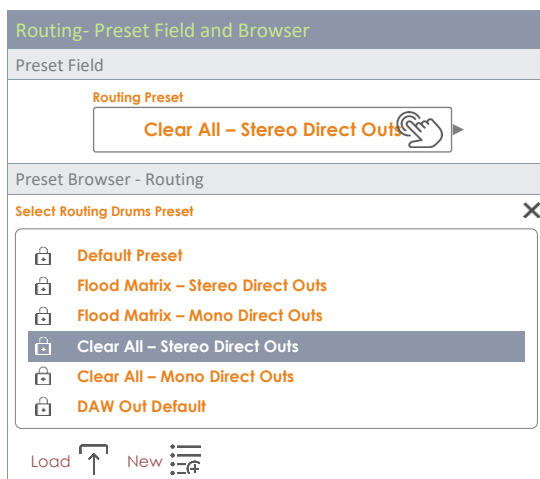

Regarding user presets, the palette of options is extended, since factory presets are not editable. To see the difference between both types, highlight them one after the other by tapping once on the corresponding list entry in the preset browser.









See the following table for comparison:

Preset Management - Dostępne funkcje					
Kategoria	Funkcje				
		Ściągnij	Zapisz	Nazwij	Nowy

 Presety fabryczne					
Presety użytkownika					

Factory presets provided serve as a starting point to avoid time consuming edits of about 100 dots manually. Chose the preset that brings you closest to the desired routing design and selectively alter the settings where needed.

The following table gives an overview over the **Factory Routing Presets**:

Factory Presets - Routing		
Routing Drums		
	Default Preset	All inputs activated for all standard outputs. Direct outs are completely muted (stereo configuration)
	Flood Matrix – Stereo Direct Outs	Activates every input channel for every output and configures direct outs completely as 4 stereo outs
	Flood Matrix – Mono Direct Outs	Activates every input channel for every output and configures direct outs completely as 8 dual mono outs
	Clear All – Stereo Direct Outs	Mutes every input channel in every output and configures direct outs completely as 4 stereo outs
	Clear All – Mono Direct Outs	Mutes every input channel in every output and configures direct outs completely as 8 dual mono outs
	DAW Out Default	Default preset with DAW configured direct outs: 2 stereo groups for toms and cymbals and 4 mono configurations for kick, snare, ride and hi-hat
Routing Others		
	Default Others Preset	Activates every input for every output
	Click on Headphones only	Removes the metronome from all outputs but the headphones

The following sections discuss the functionalities of the feature shelf.

12.1.4.2.1 LOADING PRESETS

Proceed as follows:

1. Tap on the **[Routing Preset]** field.
2. Tap once on the preset you want to load.
3. Tap **[Load]** in the Feature Shelf.

The dialog closes automatically, and the new preset is active.

12.1.4.2.2 SAVING NEW PRESETS

In preparation please check whether the **Routing Preset** field contains the name **"Custom Setting"**. This indicates that values have changed and differ from those stored in the device database.

With **Custom Setting** visible proceed as follows:

1. Tap the **[Routing Preset]** field.



2. Tap **[New]** in the Feature Shelf.
3. Name your preset using the keyboard.
4. Confirm by tapping **[OK]**.

12.1.4.2.3 OVERWRITE PRESETS

You can overwrite user presets with current values set in the interface. This function is not available for factory presets (preceding lock icon).

1. Tap in the **[Routing Preset]** field.



2. Tap on the preset name to be overwritten.
3. Tap **[Save]** in the Feature Shelf.

12.1.4.2.4 RENAMING PRESETS

Renaming a preset will affect the preset name only and retain individual parameter values. This option is only available for user presets (without preceding lock icon).

1. Tap the **[Routing Preset]** Field.
2. Tap once on a preset name in the drop-down list.
3. Tap **[Rename]** in the Feature Shelf.
4. Enter a new name for the preset using the keyboard.
5. Confirm by tapping **[OK]**.

12.1.4.2.5 DELETING USER PRESETS

This function is not available for factory presets (preceding lock icon).

Proceed as follows:

1. Tap the **[Routing Preset]** field.
2. Tap once on a preset name in the drop-down list.
3. Tap **[Delete]** in the Feature Shelf.

12.2 MODUŁ 2

The second module of the General Settings mode hosts **Equalizer** and **Compressor** features for outputs as well as **Control** settings for peripheral devices such as **Foot Switch** pedals or control via a pad using an AUX input channel.

12.2.1 MASTER CHANNEL | HEADPHONE | MONITOR OUTS

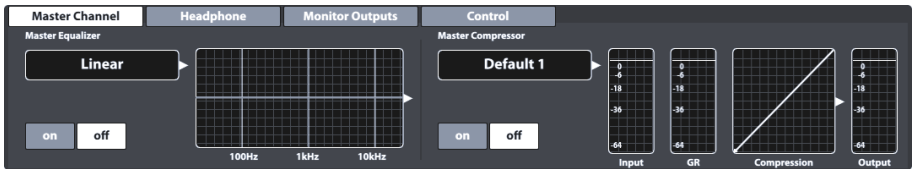

All Outputs in this module provide a 4-band full parametric equalizer and compressors that function in the same way. Therefore, we will discuss both features exemplary. Repeat the steps presented for each output if necessary and take advantage of the preset function to quickly share settings between different output types. Best results are obtained with basic knowledge in audio engineering and we recommend research of resources that cover this topic more in depth. This section will focus on the functions provided to edit the audio mix sent to the outputs of this module.

12.2.1.1 EQUALIZER

The equalizer function mainly serves to remove unwanted signals from the audio mix, such as frequencies that may cause microphone feedback in the recording environment. Since every environment is different, the need of correction and the edits required vary significantly depending on the situation. Consequently, the G9 only provides a constant linear factory preset for output channels which serves as a starting point. Recurring settings can be remembered by saving out user presets. This way you avoid repeating the editing steps when returning to a known environment or venue. The curve, that is modified by the accessible parameters displays the result of combined effects applied to the mix. **Pad Equalizers (3-Band)** are implemented as **Insert**, so that the sound of each pad can be shaped individually. The Insert property makes them audible in **Direct Outs** as well.

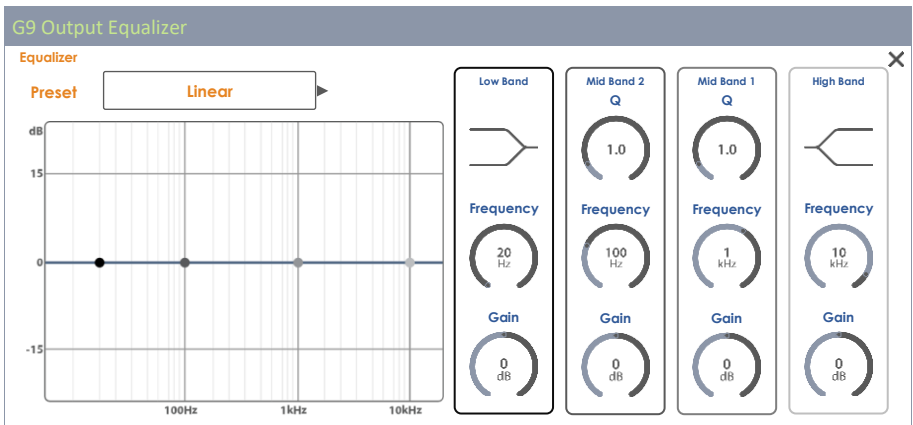

12.2.1.1.1 PARAMETERS AND DESCRIPTION

Equalizer - Parameters per Band					
Parameter	Value Range/Unit	Low Band	Mid Band 2	Mid Band 1	High Band
Shelving	---	•	---	---	•
Q Factor	0,1 – 8,0	---	•	•	---
Frequency	20 Hz -16 kHz	•	•	•	•

Gain	-15 dB – +15 dB	•	•	•	•
------	-----------------	---	---	---	---

Equalizer – Description of Parameters

Parameter	Description
Shelving	Attenuates or boosts frequencies above (High Band) or below (Low Band) a specified Shelf Frequency by the Gain Value.
Q Factor	Determines the band width or precision of the filter. Set the curvature around the edit point and consequently the width for neighboring frequencies to be affected. Low values result in sharp curvature and high values cause smoother transitions between the edit points and a broader spread of the spectrum affected by Gain .
Frequency	The frequency (mean) affected by the gain parameter. Regarding Shelving, this is the turning point in curvature.
Gain	Boosts or attenuates the set band Frequency (mean) by the amount of Gain dB adjusted. Neighboring frequencies get affected by the dB value of the Filter curve at this frequency.

12.2.1.1.2 EDITING EQ CURVES

Proceed as follows:

1. Turn Equalizer **[on]**.
2. Tap the **[Equalizer]** field which contains the editing curve.
A dialogue pops up giving you access to the EQ Parameters which modify the **Curve Points**.

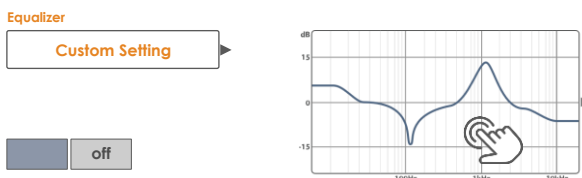

3. (Optional) Select a preset as starting point by tapping the **[Preset]** field.
Chose a preset by double tapping (alternatively: tap once on the preset name followed by a tap on **[Load]**).
4. Determine the frequency band that is closest to the disturbing frequencies in the audio mix.
5. Activate the matching frequency band on the right-hand side by tapping once on its parameter bar.
6. Note that you can access the parameters and manipulate the associated **Curve Points** in 3 alternative ways:
 - a. By tapping directly on a dial in the parameter bar
 - b. By turning the hardware dials assigned each parameter
 - c. By tapping on one of the upper three software dials next to the hardware dials

7. With the correct band activated, navigate to the middle of the problematic frequency spectrum by modifying the **Frequency** parameter. This will move curve points horizontally.
8. Modify the **Gain** parameter to adjust the desired amount of correction. This will move curve points vertically.
 - a. Decrease Gain values to mute the frequency set within the audio mix.
 - b. Increase Gain values to enhance the frequencies below the active curve point.
9. Modify the precision of the edit by manipulating the **Q** parameter (Mid Bands only). This will manipulate the curvature around the assigned curve point.
 - a. Increase the Q value to have the correction take effect in a narrow span around the chosen frequency value.
 - b. Low Q values will widen the frequency range to be affected.
10. Repeat steps 3-9 with the other frequency bands if necessary.
11. (Optional) Save changes depending on the equalizer type:
 - a. **Pad Equalizer (3-Band):** By saving the drum kit (direct) or saving an EQ preset (indirect).
 - b. **Output Equalizer (4-Band):** By creating a new EQ preset. (Output equalizers are no drum kit parameters!)

12.2.1.2 COMPRESSOR

While the **Equalizer** allows for shaping sound by addressing certain frequency ranges selectively, compressors will take effect across the whole frequency spectrum. In the G9, Pad Compressors are implemented as **Insert** type Compressors (**Input Channels** in **Kit Editor**), so that the sound of each pad can be shaped individually. The Result of Insert type compressors is audible in all outputs of the G9 including Direct Outs. Compressors available in **General Settings** affect the sound of the outputted Stereo Signal (Group Track) as a whole. Keep in mind that the effects of both types overlap and that the Output Compressors are applied on top of the pad compressors. At the Output, effects of both types will add up. However, parametrization and functioning are identical.

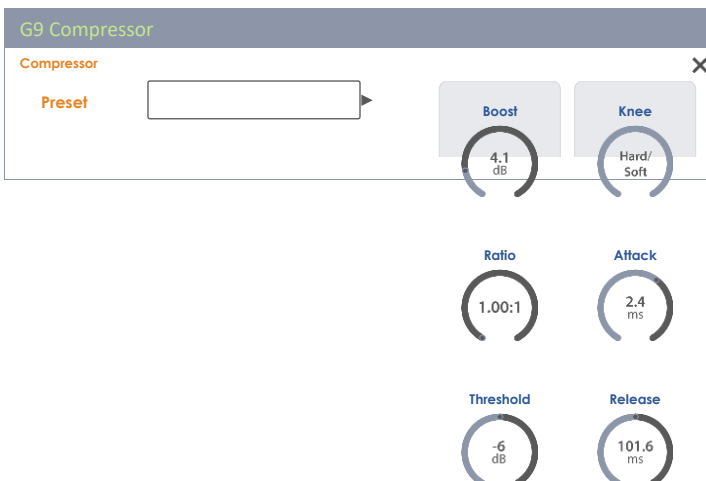

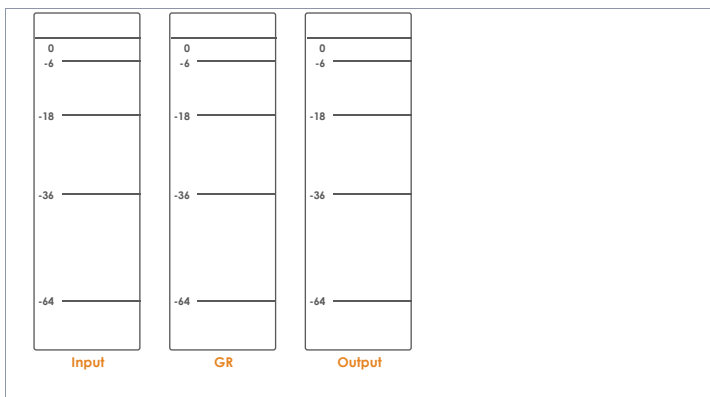

12.2.1.2.1 PARAMETERS AND DESCRIPTION

Compressor - Parameters		
Parameter	Value Range/Unit	Description
Boost	0 - 24 dB	Amplifies the compression result to compensate for the loss in levels caused by the Ratio setting. This parameter applies to the full dB spectrum of the track (threshold settings are ignored).
Ratio	1.00:1 - ∞:1	Sets the amount of compression above the Threshold as a ratio compared to the residual dB level above the Threshold . A Ratio of 1:1 equals no compression. All other parameters won't have any effect.
Threshold	-∞ - 0 dB	Creates a mask or corridor in dB where the compressor is not applied.
Knee	Hard/Soft	Determines whether the compression is faded in (soft) or whether it is applied according to the parameter settings immediately (Hard) as soon as the threshold value is exceeded. "Soft" creates a soft line of transition around the set threshold. Soft "blurs" the Threshold .
Attack	0.09 – 100 ms	Sets a delay time for the compressor to start working, as soon as the level exceeds the Threshold . This way you can keep the attack of the signal and let the compression work only on the tail above a set threshold.
Release	15.5 ms – 6 s	Sets a delay time for the compressor to stop working, as soon as the level drops below the Threshold .

i **Hint:** Boost, Ratio and Threshold settings update the input-output curve. Knee, Attack and Release values are not visible in the input-output curve.

12.2.1.2.2 EDITING COMPRESSOR CURVES

The following steps are a guideline for setting up a compressor:

1. Turn Compressor **[on]**.

- (Optional) Play a song in **Song Player** and/or play on the drum kit to hear the effect of your edits.
- Tap the **[Compression]** field which contains the input-output curve.
A dialogue pops up giving you access to the compressor parameters.

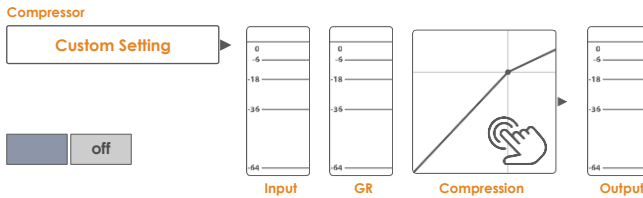

- Set the **[Threshold]** for the Compressor to start working.
- Set a **[Ratio]** of gain reduction (**GR**).
- (Optional) **[Boost]** the signal (Amplify the Signals to compensate for the loss in dB caused by the **Ratio**). Try to match input and output peak meters to bring the signals back to original dB levels without clipping.
- Set the character of transition (no compression – compression) around the **Threshold** using **[Knee]**.
- Set a delay for the compressor to start working as soon as the Level exceeds the **Threshold** using **[Attack]**.
- Set a delay for the compressor to stop working as soon as the Level drops below the **Threshold** using **[Release]**.
- (Optional) Save changes by storing the drum kit (pad compressors) or save your custom compressor as a preset (pad Compressors and output compressors).



Hint: Pad Compressors are part of the drum kit parameters and can be saved by saving the drum kit or creating a new drum kit (direct storage as "custom setting"). Output compressors in **General Settings** are stored in the device database and are remembered on next start. However, it is recommended to save out a preset to prevent the settings from being overwritten or discarded as soon as you change the drum kit.

12.2.1.3 PRESETS – EQUALIZER AND COMPRESSOR

When you apply this section to **Pad Equalizer** and **Pad Compressors** of the **Kit Editor**, note that aside from storing the preset, the **Drum Kit** may be saved as well to assign the preset permanently. Compressors and Equalizer in mode **General Settings** are no Drum Kit Parameters but are stored **automatically** in the **Device database** (either as a preset or directly). The device database does not require any separate storage, otherwise there is no difference in the structure of the preset hierarchy. You can simply replace the word "**Drum Kit**" with "**Device Database**" in the following illustration:

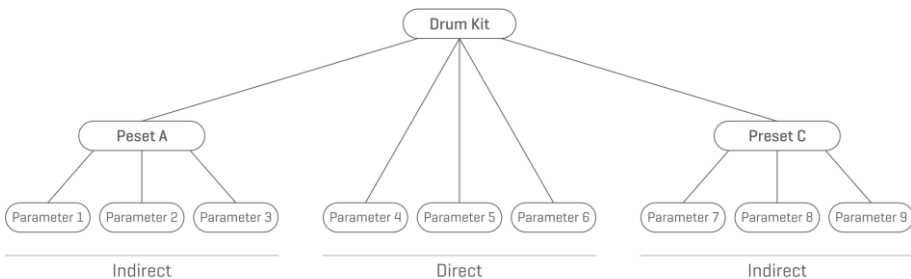

The G9 provides a variety of options to manage preset libraries. You can access the library and its functions by tapping on a **[Preset]** field next to a group of preset parameters. In the drop-down lists that open up by tapping on a preset field, the G9 differentiates between **Factory Presets** (preceding lock icon) and **User Presets** (without lock icon).

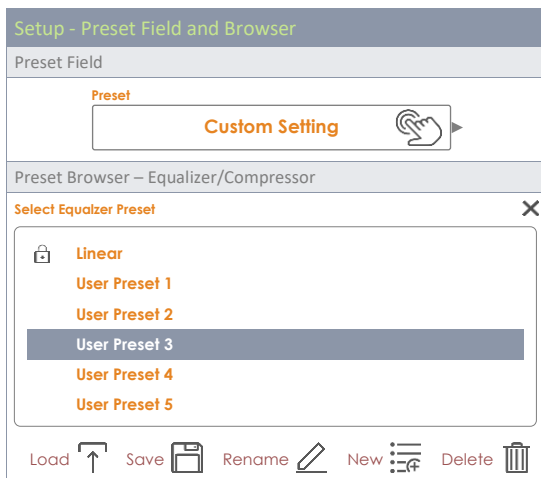

Regarding user presets, the palette of options is extended, since factory presets are not editable. To see the difference between both types, highlight them one after the other by tapping once on the corresponding list entry in the select preset browser.

See the following table for comparison:

Preset Management -Feature Shelf					
Preset Type	Function				
	Load	Save	Rename	New	Delete
🔒 Factory Preset	⬆️			☰ ☰ ☰ ☰	
User Preset	⬆️	💾	✎	☰ ☰ ☰ ☰	🗑

12.2.1.3.1 LOADING PRESETS

Proceed as follows:

1. Tap on the **[Preset]** field.
2. Tap once on the preset you want to load.
3. Tap **[Load]** in the Feature Shelf.

The dialog closes automatically, and the new preset is active.

12.2.1.3.2 SAVING NEW PRESETS

In preparation please check whether the **[Preset Field]** contains the name "**Custom Setting**". This indicates that values have changed and differ from those stored with the active drum kit (Pad Equalizer and Pad Compressor) or the values stored in the device database (Output Equalizer and Compressor).

With **Custom Setting** visible proceed as follows:

1. Tap the **[Preset]** field.



2. Tap **[New]** in the Feature Shelf.
3. Name your preset using the keyboard.
4. Confirm by tapping **[OK]**.
5. (Optional for Pad EQ and Pad Compressor) Save the active kit to replace the preset currently stored.



Hint: A newly created preset will be added to the preset library only. It is not automatically stored with the active drum kit. **Only for Pad EQ and Compressor (Kit Editor):** To ensure that the new preset loads with the kit, you will have to additionally store the drum kit afterwards. If not, changing the kit will load all presets from the last saving.

12.2.1.3.3 OVERWRITE PRESETS

You can overwrite user presets with current values set in the interface. This function is not available for factory presets (preceding lock icon).

6. Tap the **[Preset]** field.
7. Tap on the preset name to be overwritten.
8. Tap **[Save]** in the Feature Shelf.

12.2.1.3.4 RENAMING PRESETS

Renaming a preset will affect the preset name only and retain individual parameter values. This option is only available for user presets (without preceding lock icon).

1. Tap the **[Preset]** field.
2. Tap once on a preset name in the drop-down list.
3. Tap **[Rename]** in the Feature Shelf.
4. Enter a new name for the preset using the keyboard.
5. Confirm by tapping **[OK]**.

12.2.1.3.5 DELETING USER PRESETS

This function is not available for factory presets (preceding lock icon).

Proceed as follows:

1. Tap the **[Preset]** field.
2. Tap once on a preset name in the drop-down list.
3. Tap **[Delete]** in the Feature Shelf.

12.2.2 CONTROL

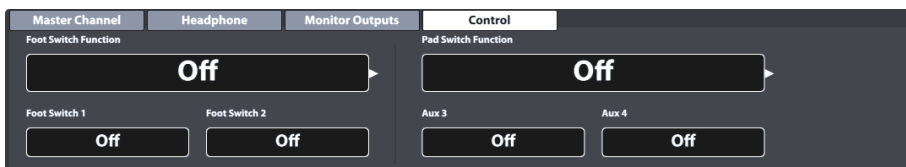

In this function set it is possible assign and manage control settings for peripheral devices choosing options from a predefined list. The G9 allows for choosing between two types of control:

1. **Foot Switch**
To be chosen in conjunction with standard foot switch pedals sending stereo signals.
2. **Pad Switch**
For the use in conjunction with standard analog drum trigger pads (stereo).

 **Hint:** Selecting Pad Switch Function will occupy the Aux 3 and Aux 4 input channels. Please make sure that you connect your pads with these inputs in the back of the console.

The options for control functions are the same for both types:

Control Options			
Control	Description	Control 1	Control 2
Off	Disables Control Function	Off	Off
Kit Select	Browse Drumkit Library	Previous Drum Kit	Next Drum Kit
Fixed Hi-Hat	Switch between fixed Hi-Hat and open Hi-Hat	Closed Hi-Hat	Open Hi-Hat
Stage Mode (Open)	Toggles between On Stage and Home Screen	Stage Mode	Home
Song Player	Controls basic Player Functions	Pause	Stop/Play
Setlist Tile Change	Cycle through Stage Tiles	Previous Setlist Tile	Next Setlist Tile
Control Sockets:	(Back of the Console)		
Foot Switch	Foot SW		
Pad Switch	Aux 3, Aux 4		

12.3 MODUŁ 3

This module hosts the **MIDI (Musical Instrument Digital Interface)** implementation of the G9 to configure the associated ports of the rear panel. Apart from that, MIDI notes sent from each pad can be defined and modified individually for MIDI outputs. These settings are hosted in **Kit Editor** mode. **General Settings** on the other hand handles global MIDI properties (*Zobacz również sekcję 9.2.2 Pad MIDI Settings na str. 48*).

For users who are new to MIDI:

Note, that MIDI is all about control data and not sound generation itself. All information sent through MIDI connections serve the purpose of controlling other devices by communicating in terms of a common language, so that other devices can interpret information received via **MIDI Input** to trigger certain events on their inside employing internal features and sounds. Thus, sound generation finally takes place in a connected, but remote device. The relationship of MIDI devices inside a MIDI network can be ambivalent: All can function as server and client at the same time.

You can compare the function of MIDI in the digital music world best to the role of sheet music in the traditional way of thinking. Sheet music contains all important information about a piece to reproduce it recognizably, everywhere, with any group of musicians and any instrument (Tempo, key, instruments, arrangement, etc.). The only condition is, that the group of musicians is familiar with reading chart music. Looking at a piece of sheet music does not play notes by itself, it requires instruments and musicians to generate a sound and play the melodies and rhythms transcribed. And as in the digital world, composer, conductor and musician can take all roles at the same time.

In the analogy above the originator is the composer, sheet music the medium and the eye of the musician the receiver. This chain of communication does have its digital counterpart in electronic music: **MIDI**. Since digital devices don't have organic eyes and brains, nor do they possess the limbs to produce the sound, a more adequate way of communication is required, which considers the functioning of a digital piece of hardware and exchanges the same quality of information as written sheet music does. An orchestra of connected, MIDI-speaking devices won't play a single note out of their sound engines if one hands out a written piece of sheet music to them, nor would they know when to change the instrument, even if it is written down on that said piece of paper. This is the task of the **MIDI Protocol**.

12.3.1 MIDI

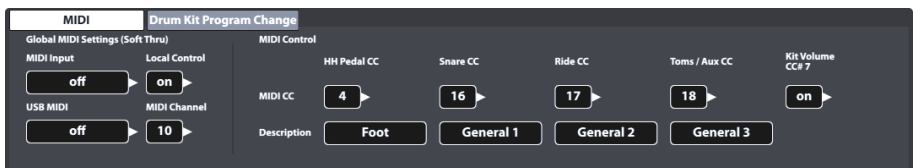



12.3.1.1 GLOBAL MIDI SETTINGS (SOFT THRU)

This function set centers around connecting the G9 with other MIDI devices to form an in-line signal path for MIDI control data to travel through. Utilizing the MIDI 1.0 protocol, it is consequently possible to remote control certain functionalities between the connected devices.

Note that in order to establish a working MIDI Data connection or chain it is crucial to know the MIDI implementation of all devices connected. Please also refer to the MIDI specifications available for

the corresponding piece of hardware. This section exclusively focuses on the MIDI implementation of the G9 and how it can live in a chain of connected MIDI devices.





Incoming MIDI Data can be routed to other MIDI devices by utilizing either the analogue **MIDI IN** port or the built in **USB-MIDI** connection. Both ports can be found in the back of the console:

Ports – MIDI	
	MIDI Out - unidirectional
	MIDI In - unidirectional
	USB-MIDI – bidirectional connection (in + out)

12.3.1.1.1 ROUTING MIDI SIGNALS

The first column of the MIDI function set specifies to which output incoming control data is directed. Tap on the corresponding fields for MIDI IN or USB-MIDI and choose the MIDI output to be addressed. Due to the limited number of outputs, no pop-up menu or option wheel will appear. Instead, tap the fields several times to cycle through the underlying list of options. Active values are displayed in the fields visible and will be stored and memorized automatically.

The following table expands the underlying menus for **MIDI Input**, **USB-MIDI**, **Local Control** and **MIDI Channel**. Tapping several times on the corresponding field in the user interface will cycle through the lists in the given order. Highlighted entries (top of the list) mark default factory settings:

G9 MIDI Routing – Fields and Options			
	MIDI Input	Local Control	Selection
	<ul style="list-style-type: none"> • off • to MIDI-Out • to USB-MIDI • to both 	<ul style="list-style-type: none"> • on • off 	
	USB-MIDI	MIDI Channel	Selection
	<ul style="list-style-type: none"> • off • to MIDI-Out 	<ul style="list-style-type: none"> • 10 • 11 • 12 • 13 • 14 • 15 • 16 • off • 1 • 2 • 3 • 4 • 5 • 6 • 7 • 8 • 9 	

Default factory settings are highlighted in bold letters.

12.3.1.1.2 LOCAL CONTROL

The next column of the **Global MIDI Settings** consists of the fields **Local Control** and **Midi Cannel**. Local Control determines whether G9 MIDI Data can drive the internal sound processor (**on**) or not (**off**). Setting Local control to "**off**" is recommended in conjunction with sequencers that rout the recorded MIDI information received from the MIDI out of the G9 back into the console to drive the internal sound processor. In this setup the G9 sound processor would receive 2 identical sets of control data if Local Control was set to "**on**". Turn off Local Control to reduce the amount of received data and avoid unnecessary duplication of signals and unwanted side effects. See the following table for reference:

G9 MIDI – Local Control		
Value	Description	MIDI Node Design
on	Control data generated by Input Channels (Pads) drives the internal sound engine (C) and can leave the device via the MIDI Outputs (A). Data looping back into the console indirectly (B) would feed the sound engine with two identical sets of data (B, C), if Local Control was on. Cut MIDI Connection B or turn off Local Control to avoid unwanted side effects.	
off	Blocks all G9 MIDI control data received from the Input Channels (Pads) from accessing the internal sound engine. This data can still control other connected equipment via the MIDI Outputs available (A). The control data routs back into the console indirectly via the external MIDI device (B).	

i **Hint:** Check the Local Control setting, if you cannot hear any sound when playing while the trigger monitors receive signals from the connected pads.

i **Hint:** Selecting **MIDI Input to Midi Out** in conjunction with **Local Control "off"** converts the MIDI Out port into a **MIDI Thru** output (Soft Thru). Choose this combination if the G9 is supposed to function as a slave down the line in a "daisy chain".

12.3.1.1.3 MIDI CHANNEL

Select the MIDI channel on which you want to transmit and receive MIDI Data. There are the 16 channels available. The factory setting is channel 10, which is commonly accepted as standard MIDI channel for percussive instruments.

12.3.1.1.4 MIDI CONTROL

The G9 provides a selected number of hardware components to control other devices or let these instruments be controlled by external MIDI devices. You have the option to assign a limited number

of **Continuous Controllers** out of the spectrum of the 127 controllers specified in the MIDI 1.0 standard.

The following table lists all available and relevant **Continuous Controllers** with their controller number and description. The latter is also displayed in the field **Description** below the controlling hardware component. It updates along with the selection of the controller number. As with the **Global Midi Settings**, the selection of controller numbers is realized by tapping the number fields several times to cycle through the underlying menu. Active controller numbers are stored automatically in the device database of the G9. The table below displays an expanded view of the underlying menus. Each controlling component connected to the corresponding **Input Channels** (HH Pedal, Snare, Ride Toms/Aux) has access to the same set of available controllers. In the factory configuration, they are set to different values. You simply start browsing the menu at a different list entry.

List of MIDI messages supported:

G9 Continuous Controllers				
CC Component		Continuous Controller (CC)	Description	Channel Selection
HHPedal CC	- Start (Default) →	• 4	Foot	
		• 11	Expression	
Snare CC	- Start (Default) →	• 16	General 1	
		Ride CC	- Start (Default) →	
Toms/Aux CC	- Start (Default) →			
		• 19	General 4	
• off	off			
• 1	Modulation			
• 2	Breath			
Kit Volume	- Start (Default) →	• on		
		• off		

12.3.2 DRUMKIT PROGRAM CHANGE

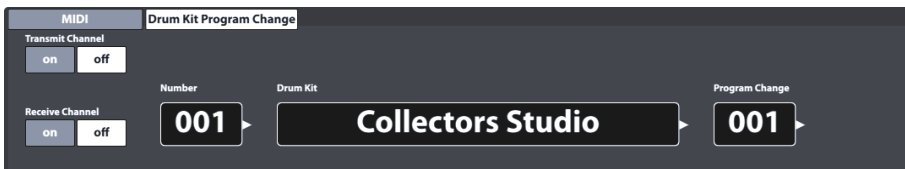

This feature set defines the rules for MIDI program changes. Since the G9 is a rhythm device, it can't be compatible with the standard MIDI protocol. The programs to change are the drum kits available in the **Drum Kit Browser**, where the **Drum Kit index number equals the program**.

Program assignments are displayed as a chain of **Internal Program** → **Internal Program Name (Drum Kit)** → **External Program**. The direction, how this chain is read or applied is defined by the channel switches (Transmit/Receive).

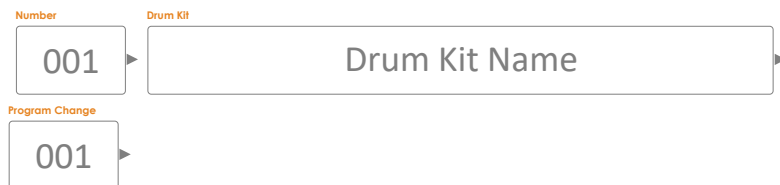



12.3.2.1 PROGRAM PAIRING

To pair an internal Program with an external MIDI Program, proceed as follows:

1. Choose an internal Program (Drum Kit) by doing one of the following:
 - a. Tap the **[Number]** field to enter a Kit Number using the number pad.
 - b. Tap the **[Drum Kit]** field to choose a kit from the **Drum Kit Browser** by double tapping.
2. Tap the **[Program Change]** field to enter a program number using the number pad.
3. (Optional) Repeat steps 1-2 for other drum kits.

The settings of the function set apply to the following ports of the rear panel. Make sure that the G9 is connected to the external device in order to let the settings have effect:

Ports – MIDI	
	MIDI Out
	MIDI In
	USB-MIDI (digital)

12.3.2.2 CHANNELS (TRANSMIT/RECEIVE)

The channels available are:

- Transmit Channel
- Receive Channel

Both channels can be turned **[on]** or **[off]** resulting in different applications of the of MIDI program assignment:

Channel States and Effects		
Transmit	Receive	Application

<input type="checkbox"/> off	<input type="checkbox"/> off	Turns program change off completely (default).
<input type="checkbox"/> on	<input type="checkbox"/> off	Only the G9 controls programs of external MIDI devices by changing the drum kit.
<input type="checkbox"/> off	<input type="checkbox"/> on	The G9 only reacts to external MIDI program changes by changing the kit according to the linkage of programs in program chain.
<input type="checkbox"/> on	<input type="checkbox"/> on	Change programs of external devices and accept the drum kit to be changed by external MIDI program changes.

Turn **Transmit Channel** on, if you like to change MIDI programs of external devices by changing your drum kit. Turn on **Receive Channel** if you want your drum kits to be changed by external MIDI devices. Turn on both channels, if you want to be able to change other device programs by changing the kit and at the same time accept your kit to be changed depending on a change of external programs.



Hint: Assignments made in this function set will be stored in the device database and are remembered on next start-up.

12.4 MODUŁ 4

The last module of the General Settings mode hosts all global device adjustments. The features hosted comprise a **shutdown timer**, appearance of the screen and knobs, **UI Themes** as well as important **information about the device**. This module also manages **wireless connections** and allows for performing a **factory resets** and **Updates**.

12.4.1 DEVICE

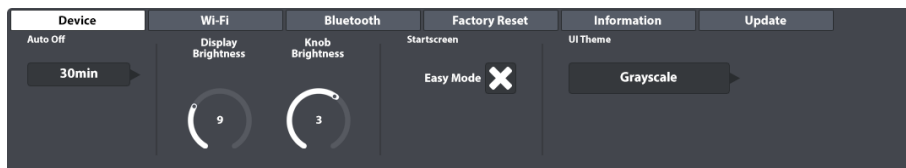

This function set controls all adjustments regarding UI elements. You can adjust **Knob Brightness** and **Display Brightness** independently from each other, as well as programming a timer for shut down. If you feel restricted by the **Easy Mode**, simply uncheck **Start Screen Easy Mode**. From the next restart on the G9 will boot into **Performance Mode**. Parallel to that, the Performance mode will also be set as default screen when pressing the red **Home Button**.



Home Button

12.4.1.1 AUTO OFF

With **Auto Off** you can time when the G9 shuts down. Tap repeatedly the **[Auto Off]** field to cycle through the countdown times available. There are five options: **off** → **30 mins (default)** → **1h** → **2h** → **4h**.

12.4.1.2 KNOB BRIGHTNESS

To adjust the **Knob Brightness**, proceed as follows:

1. Tap once on the corresponding visual dial to activate the fader.

2. Drag your finger up and down until you find a brightness you are happy with.
3. Close the fader by tapping on the dial icon again.



Hint: Brightness adjustments are stored real-time, meaning that the last brightness value set will be kept and saved in the global device database, even if you leave the mode.

12.4.1.3 START SCREEN

By unchecking "Start screen Easy Mode" the G9 will be act as follows:

- The device boots in **Performance Mode** on next start up.
- Performance Mode is set as default screen when pressing the red home button.

12.4.1.4 UI THEME

The appearance of the G9 is customizable by different UI Themes. Tap on the field and select a theme using the selection wheel.

There are also themes dedicated to different types of color blindness. These themes are named after medical terms and utilize only color values from the perceivable spectrum of the concerned group of people.

Themes dedicated to color blindness are:

- Deuteranopia
- Protanopia
- Tritanopia
- Grayscale



Hint: Themes dedicated to color blindness change colors in important monitors of the UI as well. The interpretation of these monitors depends on the colors visible. Color values and their meanings are explained in the relevant sections of this manual. To this end it is recommended reading this manual on a screen or printing it in color.

12.4.2 Wi-Fi

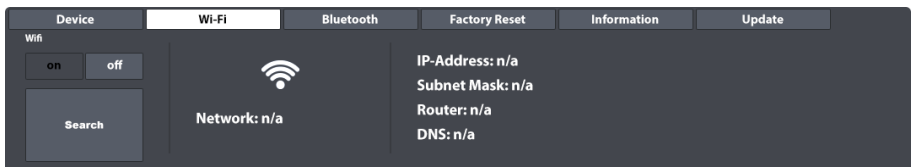

Within this function set you can manage all your Wi-Fi connections and settings. The Wi-Fi connection is essential to the use of the sound store online as well as the internal update function. To establish a Wi-Fi connection between the built-in card and the external router, proceed as follows:

1. Turn on Wi-Fi.
2. Tap the **[Search]** button.
3. Select a Network from the List that opens up tapping once.
4. Tap **[Select]** once.
5. (Optional) Tap the field **[Network Key]**, if the network requires a password.
6. (Optional) Enter the Wi-Fi password using the keyboard.

7. (Optional) Confirm by tapping the **Hook [✓]** to close the keyboard.
8. Tap **[connect]**.

Consequently, the network will update to the network selected in step 3. If your connection has been established successfully, all connection information such as IP-Address and Subnet mask will appear on the right-hand side. If no information appears, please repeat steps above with **show key** set to "on" (step 5) and make sure that you have entered the Wi-Fi password correctly.

12.4.3 BLUETOOTH

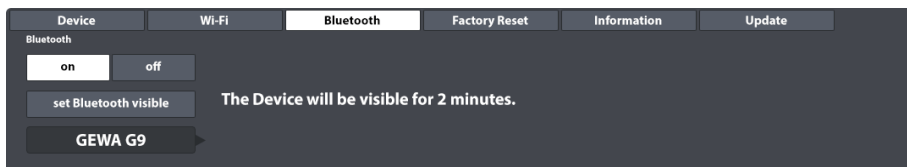

The built in Bluetooth function is useful for streaming music from an external player into the console. To establish a Bluetooth connection, you need to follow the steps below. Note that steps 2-5 take place on your mobile device and the procedure might vary from manufacturer to manufacturer. Please refer to the owner's manual of your mobile device if you have problems establishing a working Bluetooth connection:

1. W GEWA G9 wejdź do **General Settings → Module 4 → Bluetooth**
2. Upewnij się, że jest on włączony **[on]** i naciśnij **[set Bluetooth visible]**.
3. Turn on Bluetooth in your external device and open the list of available network connections.
4. Scan to refresh the list.
5. Select the console from the list of available devices (e.g. GEWA G9).
6. Enter the Bluetooth password (factory default: **4392**).



The password is fixed and unified for all GEWA drum consoles and digital pianos. Enter **4392** (as if you were writing GEWA on a number pad).

i **Porada:** Bądź świadomy **interakcji między Bluetooth a portem MIX IN**. Sygnały Bluetooth i sygnały z portu MIX IN nie mogą być odtwarzane jednocześnie. Gdy tylko Bluetooth zostanie włączony, sygnały audio z podłączonych urządzeń na porcie MIX IN zostaną wyciszone. G9 kieruje sygnały z priorytetem dla ostatniej akcji. W związku z tym podłączenie kabla audio do portu MIX IN podczas odtwarzania dźwięku przez Bluetooth spowoduje wyciszenie dźwięku Bluetooth i nadanie priorytetu MIX IN. Wyłączenie jednego z tych typów wejścia przez odłączenie kabli MIX IN lub wyłączenie Bluetooth spowoduje automatyczne przełączenie urządzenia na inny typ wejścia.

12.4.3.1 CUSTOM BLUETOOTH NAMES

If your G9 is in the close neighborhood of other G9 devices, you can change the Bluetooth name of your G9 to make it uniquely recognizable for other external devices and facilitate the pairing process. Bluetooth names are stored in the global device database automatically and are remembered until changing the name again or until performing a **Factory Reset**.

Proceed as follows:

1. Go to **General Settings** → **Moduł 4** → **Bluetooth**
2. Tap the **[Bluetooth Name field]** below **[set Bluetooth visible]**.



3. In the dialog that opens you have two options:
 - a. Tap **[set Name]** to close the dialogue and set the name shown in the display.
 - b. Tap the field containing the current **[Bluetooth Name]** and enter a custom name using the **Keyboard**.

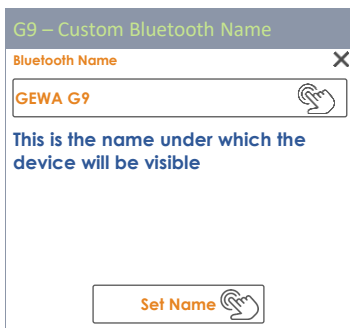

4. Confirm by tapping the Hook in the Keyboard.

12.4.4 FABRYCZNY RESET (FACTORY RESET)

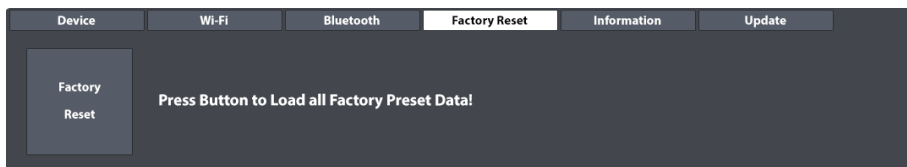

Przywrócenie ustawień fabrycznych przywoła domyślne ustawienia zainstalowanej wersji oprogramowania. Procedura usuwa niestandardowe zestawy bębnow, ustawienia wstępne i parametry urządzenia zmienione w ostatniej aktualizacji oprogramowania. Możliwe jest jednak utworzenie kopii zapasowej zestawów perkusyjnych za pomocą funkcji eksportu zestawu perkusyjnego. Procedura eksportu zapisze wszystkie zestawy bębnow w domyślnym folderze systemowym na wewnętrznej karcie SD, która jest wyłączona z przywracania ustawień fabrycznych. W ten sposób można łatwo zaimportować zestawy bębnow po przywróceniu ustawień fabrycznych. Dźwięki zakupione w sklepie muszą zostać pobrane i ponownie zaimportowane. Aktualizacja firmware z drugiej strony zachowa wszystkie ustawienia i zestawy perkusyjne. Przed kontynuowaniem zapisz niestandardowe zestawy perkusyjne.

Aby przywrócić ustawienia fabryczne G9, wykonaj następujące czynności:

1. Idź do **General Settings** → **Moduł 4** → **Factory Reset**
2. Dotknij **[Factory Reset]**.
3. Poczekaj, aż fabryczny reset wykona czynność do końca.

- Potwierdź poprzez oznaczenie **haczyk** [✓] w części dialogowej.

12.4.5 INFORMATION

Device	Wi-Fi	Bluetooth	Factory Reset	Information	Update
Serial Number: TS2002197				SD Memory used / total: 5,98 GB / 115.21 GB	
Firmware: V 1.18				Sample Flash used / total: 2,00 GB / 4.00 GB	
Dream FW: V 1.30					
Trigger FW: V 20200711					
SoundBank: V 1.05					
TriggerBank: V 20200723					

This section provides you with all information of the G9's status such as **Serial Number**, **Firmware** version, sound chip firmware version (**Dream**) and version number of the trigger database (**Trigger**). Also shown is the status of the usage of the internal memory (**Flash** for imported sample Libraries and **SD Memory**).

Please always communicate Firmware/Dream and Trigger Versions when contacting the customer service. This information speeds up the process of solving issues.

12.4.6 UPDATE

Device	Wi-Fi	Bluetooth	Factory Reset	Information	Update
Firmware Update					Installation
User's Manual Language	English				Firmware Version 9.9.99 is ready to install.
Check for Update					Show Info

G9 zapewnia dwa różne sposoby pobierania oprogramowania oraz instrukcji, a także dwie opcje aktualizacji urządzenia. Proces aktualizacji jest podzielony na 2 etapy: Pobierz i zaktualizuj. Możesz wybierać między pobraniami z centrum pomocy technicznej na stronie gewamusic.com lub pobierać bezpośrednio do G9 za pomocą funkcji pobierania karty aktualizacji. Sama procedura aktualizacji może być wykonana z pamięci USB lub z wewnętrznej **funkcji aktualizacji** stacji roboczej. Który sposób wybierzesz zależy od Ciebie. Jednak przy dostępnym działającym połączeniu Wi-Fi zaleca się całkowite wykorzystanie stacji roboczej do pobierania i aktualizacji.

12.4.6.1 DOWNLOAD/POBIERANIE – FIRMWARE, INSTRUKCJA

Zarówno strona internetowa, jak i moduł G9 czerpią swoje pliki z tego samego źródła, zatem to od Ciebie zależy, którą drogę wybierzesz.

12.4.6.1.1 DOWNLOADS/POBIERANIE Z GEWAMUSIC.COM

- Wejdź na gewamusic.com → Service → Downloads
Lub skorzystaj z linku poniżej:

<https://pl.gewamusic.com/downloads>

- Wybierz „Drums” z opcji.
- Pobierz pliki zgodnie z instrukcjami.



12.4.6.1.2 POBIERANIE BEZPOŚREDNIE Z URZĄDZENIA



Funkcja bezpośredniego pobierania pozwala uniknąć zakłóceń nośników pośrednich, co skutkuje szybką i łatwą procedurą aktualizowania G9.

Wykonaj następujące kroki:

1. Upewnij się, że ustanowiłeś działające połączenie Wi-Fi.
2. Idź do **General Settings** → **Moduł 4** → **Update**
3. Naciśnij na **[Language field]** wybrać język instrukcji.
4. Naciśnij **[Check for Update (Sprawdź dostępność aktualizacji)]**, aby otworzyć okno dialogowe aktualizacji.

Po wybraniu języka, **przeglądarka G9 Update** zbiera wszystkie odpowiednie pliki do pobrania w wybranym języku, sprawdzając przy tym zainstalowane oprogramowanie. Dostarczone zostanie tylko oprogramowanie nowsze niż wersja zainstalowana. Aby przywrócić zainstalowane oprogramowanie sprzętowe, wykonaj reset fabryczny. Dziennik zmian zawiera ważne informacje o tym, czego użytkownik może oczekiwać od dostarczonego pliku do pobrania. Korzystając z tej metody, hfirmware i podręcznik są pobierane w tym samym czasie.

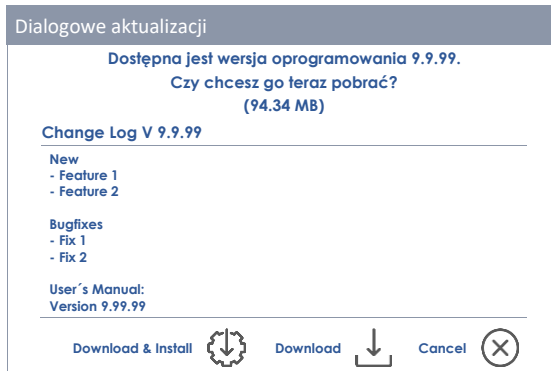

5. Wybierz jedną z następujących opcji przycisku dialogowego:
 - a. Naciśnij **[Download & Install (Pobierz i zainstaluj)]**, aby zainstalować oprogramowanie automatycznie po pobraniu.
 - b. Naciśnij **[Download (Pobierz)]** aby tylko pobrać plik.
 - c. Naciśnij **[Cancel (Anuluj)]** aby przerwać i zamknąć.
6. W przypadku 5a poczekaj na zakończeniu procedury aktualizacji i potwierdź ją, dotykając **[Reboot (Uruchom ponownie)]**.

Jeśli chcesz skopiować instrukcję obsługi do pamięci USB lub jeśli wolisz skorzystać z opcji aktualizacji przez USB, możesz znaleźć pliki do pobrania w domyślnych folderach systemowych na wewnętrznej

karcie SD. Użyj Menedżera plików, aby uzyskać dostęp do swoich pobrań. (Idź do **Tools** → **File Manager**)

Odpowiednie ścieżki folderów to:

- Firmware: **INTERNAL SD/SYSTEM/Firmware**
- Manuals: **INTERNAL SD/SYSTEM/Manuals**

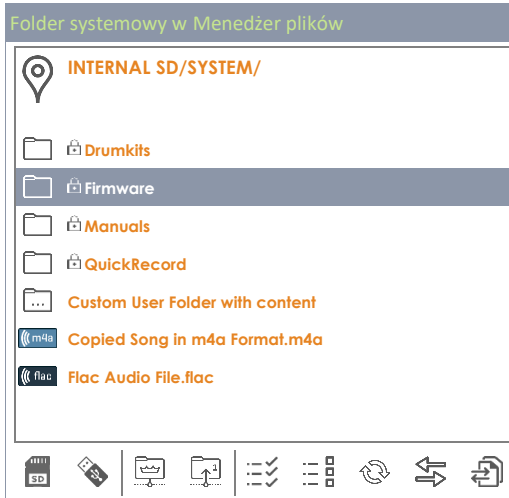

12.4.6.2 AKTUALZUJ URZĄDZWNIE

Ważne: Należy pamiętać, że procedura aktualizacji wymaga określonej konwencji nazewnictwa plików i rozszerzenia pliku, aby działała poprawnie. **Nie zmieniaj nazw plików oprogramowania sprzętowego ani ich nie modyfikuj (*.swu).**

12.4.6.2.1 AKTUALIZACJA OPROGRAMOWANIA PRZEZ USB

Postępuj wg. Instrukcji poniżej:

1. Rozpakuj pobrane pliki.
2. Skopiuj oprogramowanie (edrum_fw_*.swu) do katalogu ROOT pamięci USB.
3. Wyłącz G9, naciskając przycisk zasilania.
4. Podłącz pamięć USB do portu USB na panelu przednim.
5. Włącz G9, naciskając ponownie przycisk zasilania i poczekaj na zakończenie aktualizacji (wyskoczy z komunikatem o stanie aktualizacji).
6. Wyjmij pamięć USB z portu USB.
7. Nacisnij **[Reboot]** w komunikacie.

G9 - Aktualizacja oprogramowania przez USB

1

2

3

4

5

6

7

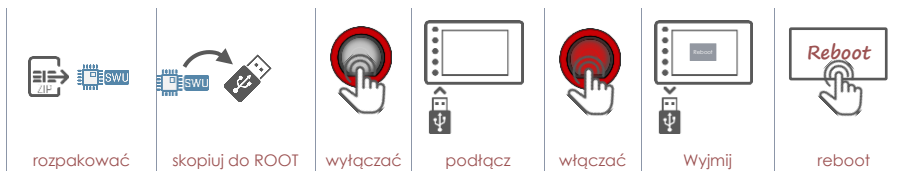

Wskazówka: Sprawdź pomyślną aktualizację na karcie informacji. Idź do **General Settings** → **Moduł 4** → **Information**. Wersja oprogramowania układowego powinna zostać zaktualizowana. Jeśli zauważysz wersję triggerów V0, konieczne ponowne uruchomienie modułu.

Wskazówka: W połączeniu z bezpośrednim pobieraniem oprogramowania można pobrać również rozpakowane oprogramowanie z domyślnego folderu pobierania i skopiować je na pamięć USB za pomocą Menedżera plików (File Manager) G9. Domyślna ścieżka pobierania plików oprogramowania to **INTERNAL SD/SYSTEM/Firmware**.

Wskazówka: Zarezerwuj pamięć USB tylko dla aktualizacji. Po podłączeniu pamięci USB oraz przeniesieniu plików aktualizacji oprogramowania do folderu głównego, moduł G9 automatycznie rozpoczyna procedurę aktualizacji, nawet jeśli wersja oprogramowania jest już zainstalowana. Oszczędzaj czas, używając „kluczy sprzętowych” USB w różnych celach lub alternatywnie, usuń dowolny plik *.swu z katalogu głównego zaraz po aktualizacji.

Wskazówka: Zarezerwuj pamięć USB tylko dla aktualizacji. Po podłączeniu pamięci USB oraz przeniesieniu plików aktualizacji oprogramowania do folderu głównego, moduł G9 automatycznie rozpoczyna procedurę aktualizacji, nawet jeśli wersja oprogramowania jest już zainstalowana. Oszczędzaj czas, używając „kluczy sprzętowych” USB w różnych celach lub alternatywnie, usuń dowolny plik *.swu z katalogu głównego zaraz po aktualizacji.

12.4.6.2.2 AKTUALIZUJ PROCEDURĘ ZA POMOCĄ MODUŁU

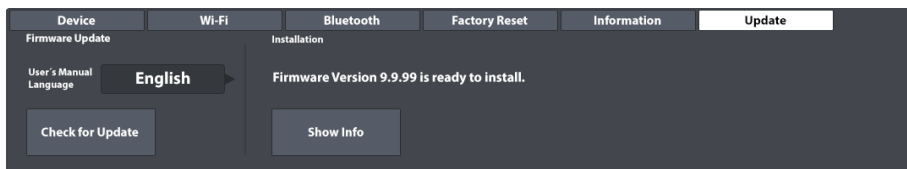

Sekcja aktualizacji G9 komunikuje się z domyślnym folderem SYSTEM „Firmware” na wewnętrznej **karcie SD**. Uwzględnione zostaną wszystkie pliki spełniające kryteria sum kontrolnych, konwencji nazewnictwa i numeru wersji, a najnowsza poprawna wersja oprogramowania sprzętowego zostanie uruchomiona do instalacji. Oznacza to, że uwzględniane są tylko kompletne i poprawne pliki, których numer wersji jest wyższy niż numer wersji oprogramowania sprzętowego. W tym sensie sekcja aktualizacji działa jako zapora ogniowa dla uszkodzonych i zmodyfikowanych plików.

Aby zainstalować wcześniej pobrane oprogramowanie, wykonaj następujące czynności:

1. Idź do **General Settings** → **Moduł 4** → **Update**
2. W pobrane uaktualnienia oprogramowania spowodują pojawienie się powiadomień na karcie aktualizacja. Do instalacji zostanie wybrana tylko najnowsza wersja.
3. W sekcji Instalacja naciśnij **[Show Info (Pokaż informacje)]**.
4. W oknie dialogowym aktualizacja naciśnij przycisk **[Install (Zainstaluj)]**.

5. Poczekaj na zakończenie autonomicznej procedury aktualizacji (komunikat o powodzeniu).
6. Potwierdź naciskając **[Reboot (Uruchom ponownie)]**.

13 NARZĘDZI (TOOLS)



Tryb narzędzi zawiera podobne do aplikacji funkcje, takie jak tryb **On Stage**, **Czytnik PDF (PDF Reader)**, **Narzędzia do importowania (Import Tool)** i **Menedżer plików (File Manager)**.

Stuknięcie ikony w menu Narzędzia spowoduje otwarcie powiązanej aplikacji. Poniższa tabela zawiera ikony związane z dostępnymi narzędziami:

Tools Menu	
	On Stage – kompiluje media dla ustawień, w tym wykresy w formacie pdf
	Czytnik PDF (PDF Reader) – Obsługa zakładek
	Narzędzia do importowania (Import Tool) - dodaj próbki do biblioteki dźwięków
	Menedżer plików (File Manager) – organizacja plików i folderów
	Sklep (Shop) – wyświetla listę zakupionych brzmień

13.1 ON STAGE



With the **On Stage** tool it is possible to compile important information around a song such as drum kit (sound), metronome, backing tracks and pdf charts, and make altogether available by tapping on one of the numbered tiles. This way you can avoid time consuming adjustments on stage and between the songs.

The **On Stage** screen always displays 8 tiles which can be saved as preset setlists and which can be loaded one after the other as the gig progresses. A setlist always consists of 8 tiles, representing 8 songs.

To open the On Stage tool, tap the **[Tools]** mode icon and tap **[On Stage]**.

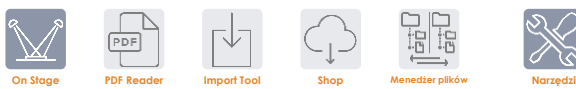

This opens the default On Stage screen:

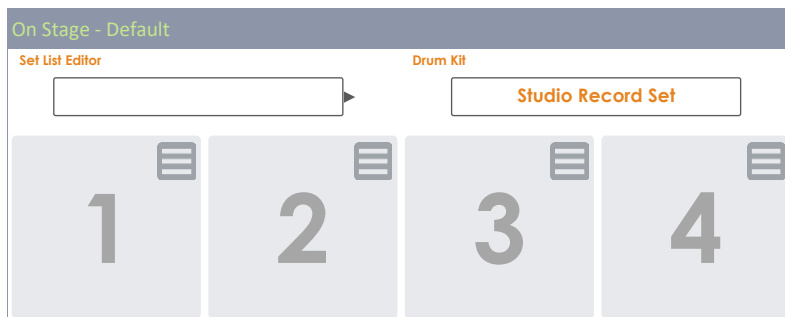

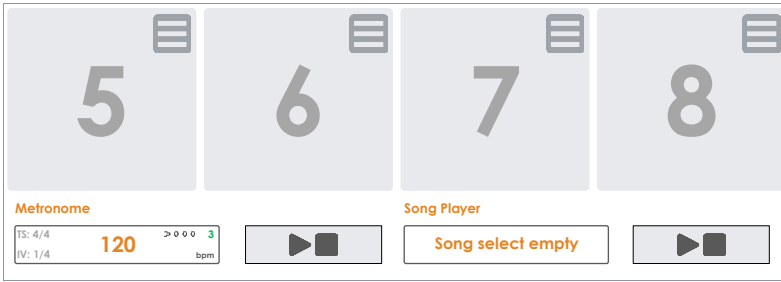

The following sections will focus on editing files, managing setlists and working with setlists on stage.

13.1.1 TILES – ASSIGNABLE MEDIA TYPES

While editing a tile you can specify settings and files for the following 4 types of media, which will be loaded when tapping on the tile number outside the edit mode:

- Drum Kit Name
- Metronome Tempo
- Backing Track (Song Player)
- Pdf files (Lead sheets or Charts)

The fields on screen associated with these media types will display the current tile expressions specified for each type. In edit mode you can tap these fields to change the properties of the tile.

This will open the standard dialogues associated with a media type. In this section we won't go into depth about these browsers again. See the following table for the dialogues implemented and the chapter where their functioning is explained in more detail:

Tiles - Media Types and Associated Dialogues		
Field Name	Dialog	Section - Title
Drum Kit	Drum Kit Browser	8.1.1.1 Zarządzanie zestawami perkusyjnymi (Presety)
Metronome	Number Pad	8.4.1 Metronom (Metronome)
Song Player	File Select (Audio Filter)	8.3.1.1 Przeglądarka plików (File Select Browser)
PDF	File Select (PDF Filter)	13.2.1 Przeglądarka plików (File Select Browser)

13.1.2 EDITING TILES – ASSIGN EXPRESSIONS FOR MEDIA TYPES

In preparation, please tap the **[Setlist Editor]** field and load the preset **Blank Sheet** by double tapping on the preset name. This will load an empty setlist with default values. The proceeding described in the following applies to creating new presets using the blank sheet preset as well as editing tiles of any other existing setlist.

Tile Edit – Icons and their Meaning	
	Edit Tile
	Attach PDF File (Tap) – Remove File (Hold down 2 seconds)

With an adequate setlist loaded, proceed as follows:

1. Tap on the **[Edit]** button in the top-right corner of a file.
2. Tap the fields that have changed color
 - a. Drum Kit
 - b. Metronome
 - c. Song Player
 - d. Attach Pdf button
3. Specify the expression of media types in the browsers that open up.
4. Exit the file edit mode by tapping the **[Edit]** button again.
5. Tap the next file number and repeat steps 1-4.
6. When having edited maximally all 8 files on screen, save the file set as a **Setlist** (see the next section on set lists).

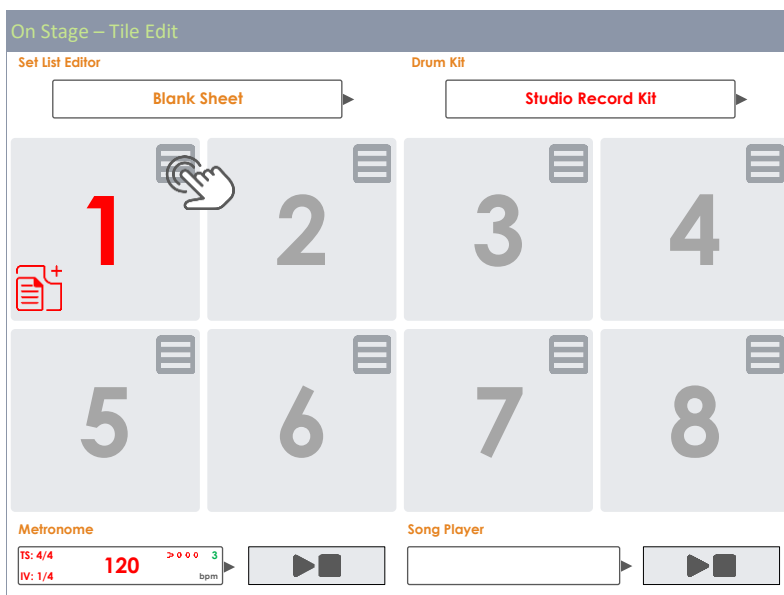

13.1.3 SETLIST PRESETS

A set of 8 occupied tiles can be saved as a setlist, which remembers all media types assigned to the different files once the setlist is loaded. The UI will update as soon as a file of the loaded setlist is activated. A setlist is the same as a preset and is treated the same way. Regarding setlists, the preset browser provides only one preset called **"Blank Sheet"**. This preset loads default values without any pdf attachment. If you are already familiar with preset management in other modes such as **Kit Editor** or **Effects**, you can skip this section.

Setlists - Preset Field and Browser

Preset Field

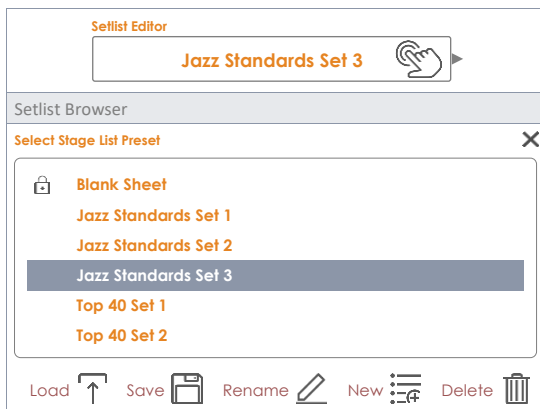

As with all other G9 presets, the feature shelf updates depending on the chosen preset type (Factory or User):

Preset Management - Dostępne funkcje					
Kategoria	Funkcje				
	Ściągnij	Zapisz	Nazwij	Nowy	Skasuj
🔒 Presety fabryczne	⬆️			☰☒	
Presety użytkownika	⬆️	💾	✎	☰☒	🗑

13.1.3.1 LOADING SETLISTS

To load a Setlist proceed as follows:

1. Tap the **[Setlist Editor]** field to open the Setlist Browser.



2. To Load a Setlist do one of the following:
 - a. Via **Feature Shelf**
 - i. Highlight a list entry (Tap once).
 - ii. Tap **[Load]** in the Feature Shelf.
 - b. Double tap a list entry.



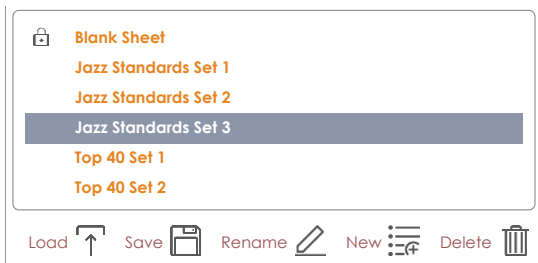

13.1.3.2 NEW SETLISTS

Proceed as follows:

1. Load a preset to start from.
2. Edit the files as desired (The **Setlist Editor** field updates to "**Custom Setup**").



3. Tap the **[Setlist Editor]** field to open the setlist browser.
4. Tap **[New]** in the Feature Shelf.
5. Name the new setlist using the keyboard.
6. Tap **[OK]** to confirm.

i **Hint:** It is possible to create a new setlist before editing the files: Load a preset to start from, open the preset browser again and tap **[New]**. After that you can edit the files and overwrite the preset with **[Save]**.

13.1.3.3 SAVE SETLISTS

Save allows for saving edits of a setlist as well as overwriting presets in the setlist browser with the values of the current file set. This option is only available for user setlists.

Proceed as follows:

1. Load a preset to start with.
2. Edit the files as desired (The **Setlist Editor** field changes to "**Custom Setup**").



3. Tap the **[Setlist Editor]** field to open the setlist browser.
4. In the preset browser highlight a user setlist to be overwritten (tap once).
5. Tap **[Save]** in Feature Shelf.

This overwrites the chosen preset with the current file layout.

13.1.3.4 RENAME SETLISTS

Renaming of setlists is always possible without overwriting their file configuration. This option is only available for user setlists.

Proceed as follows:

1. Tap the **[Setlist Editor]** field to open the setlist browser.
2. In the preset browser highlight a user setlist to be renamed (tap once).
3. Tap **[Rename]** in the Feature Shelf.
4. Enter a new name using the keyboard.
5. Confirm by tapping **[OK]**.

13.1.3.5 DELETE SETLISTS

This option is only available for user setlists.





Proceed as follows:

1. Tap the **[Setlist Editor]** field to open the setlist browser.
2. In the preset browser highlight a user setlist to be deleted (tap once).
3. Tap **[Delete]** in the Feature Shelf.
4. Confirm by tapping **[OK]**.

13.1.4 WORKING WITH SETLISTS

Setlists can be used in different ways. Their main purpose is to make available important settings associated with a song by tapping a single button (file number). But also, during your practice routines it can contribute to a more efficient time management by providing matching charts, drum kits, tempo and audio files. Tapping a file number is very convenient instead of selecting all media individually in **Performance** mode and **Czytnik PDF (PDF Reader)** every time you sit down to practice the same song.

Tapping a file number gives access to all media assigned to a file. See the following table for icons and buttons that can appear within a file:

Loaded Setlists– Icons and their Meaning	
	Edit Tile
	Attached File
	Open File in Pdf Viewer
	Play/Stop (Song and Metronome)





If set lists are longer than 8 songs, it is possible to spread the songs over several **On Stage Setlists** and load these lists one after the other.

13.1.4.1 PDF VIEWER

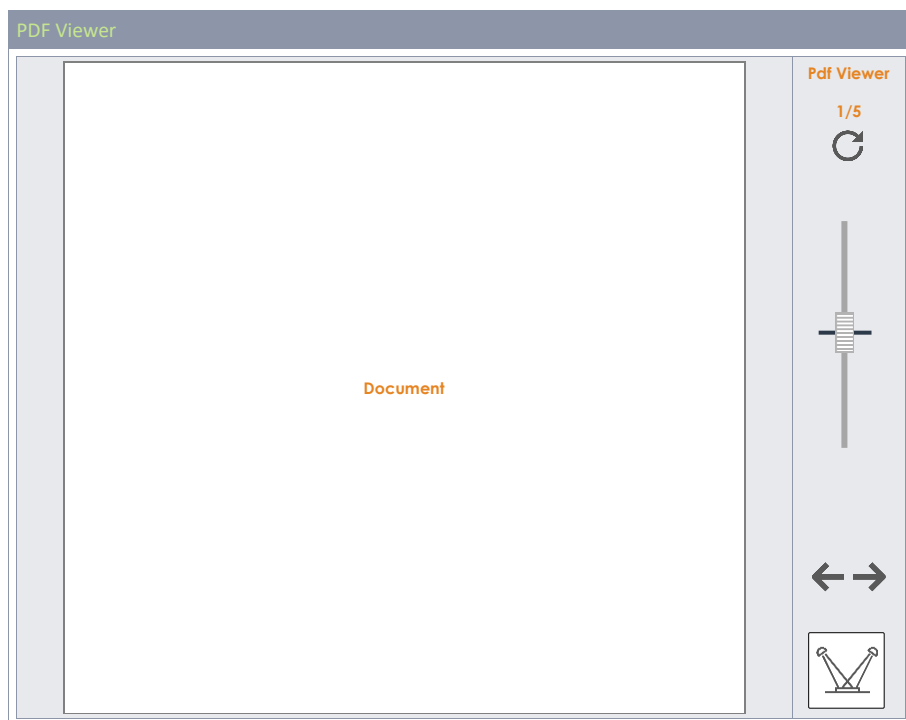
The On Stage Pdf Viewer is a simplified version of the Czytnik PDF (PDF Reader) (*Zobacz na str. 134*). It provides only the most important functions for reading chart music. During live performances you need to turn pages quickly and have fast access to the **[Play/Stop]** buttons of the On Stage mode

to quickly react to issues on stage. The built-in **[Exit]** button closes the Pdf viewer and returns to the active file in **On Stage** mode. The allocation of these functions at the bottom minimizes the distance to the player and thus speeds up the workflow.



Pdf Viewer	
	Exit to On Stage Screen (Closes Pdf Viewer)
	Next page
	Previous page
	Zoom
	Turn page clockwise

13.2 CZYTNIK PDF (PDF READER)



The Czytnik PDF (PDF Reader) allows you to read any PDF stored onto a USB stick or the internal memory, which is especially useful for reading sheet music. Next to basic navigation functions, it also provides advanced functions such as **bookmark navigation** and **thumbnail navigation**.



On Stage



PDF Reader



Import Tool



Shop



Menedżer plików



Narzędzi

Tapping on **Tools** → **Pdf Reader** will open the application. All functions available are visible in the start screen:

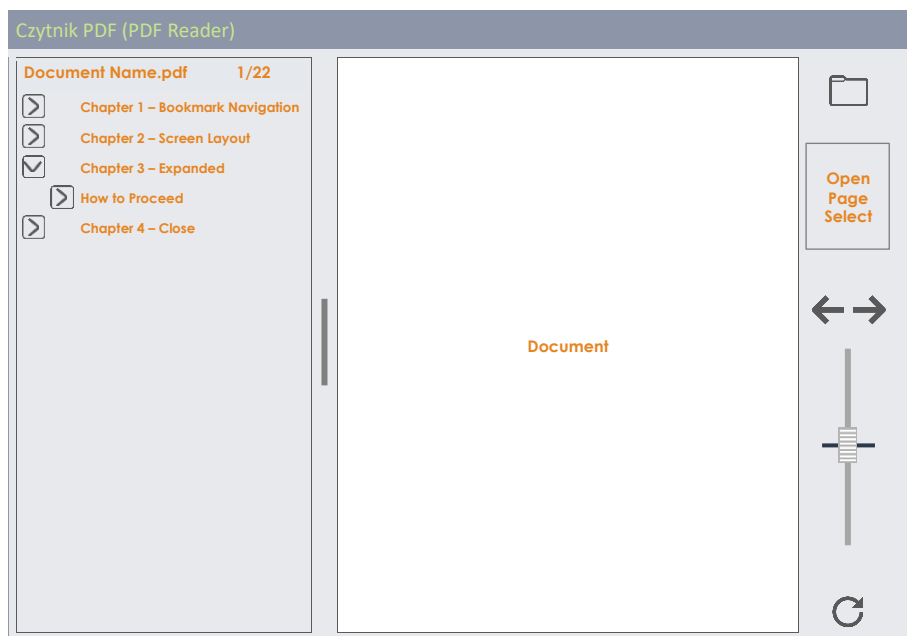

The following table explains buttons and icons of the start screen:

Czytnik PDF (PDF Reader) - Functions	
	Open File Select Browser
	Next page
	Previous page
	Zoom
	Rotate page clockwise in Increments of 90°
	Expand bookmark hierarchy

▼ Collapse bookmark hierarchy

13.2.1 PRZEGLĄDARKA PLIKÓW (FILE SELECT BROWSER)

Przeglądarka File Select jest zaimplementowana w różnych aplikacjach w G9, takich jak **Odtwarzanie utworów (Song Player)**, **Czytnik PDF (PDF Reader)** lub **Narzędzia do importowania (Import Tool)**. Jednak w zależności od aplikacji otwiera się z różnymi aktywnymi filtrami, aby wyświetlać tylko odpowiednie typy plików. Jeśli chodzi o **Czytnik PDF**, wyświetla tylko wszystkie istotne **pliki PDF**. W związku z tym niewłaściwe pliki są ukryte i wyzarzone.

13.2.1.1 WŁAŚCIWOŚCI

W lewym górnym rogu znajdują się przyciski służące do **wybijania nośników pamięci**, a także **funkcja wyszukiwania**, która może być wykorzystana jako alternatywa dla nawigacji po liniowej ścieżce. Wszystkie te przyciski są aktywowane **jednym dotknięciem**.

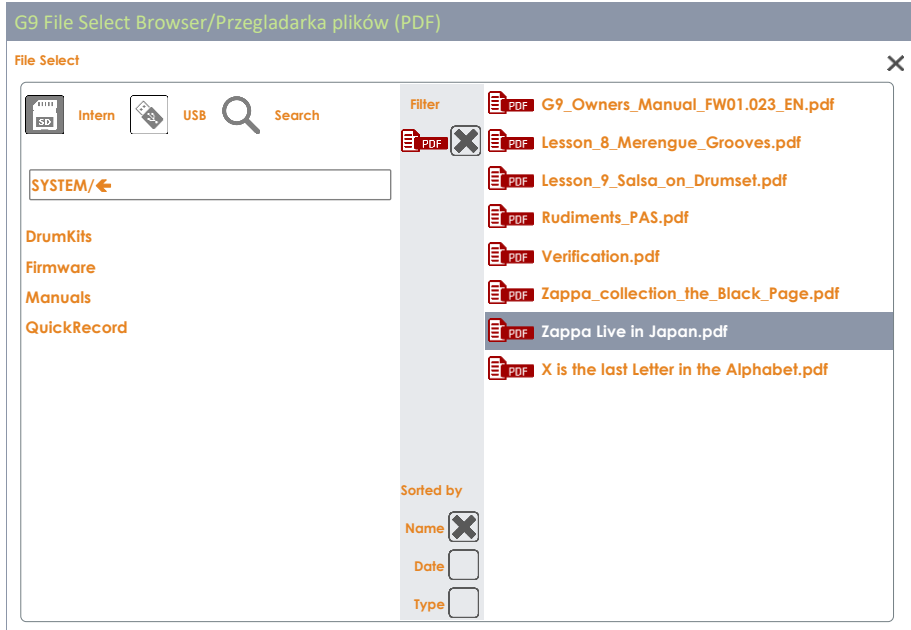

Lewa kolumna wyświetla wszystkie **foldery** w otwartym katalogu, prawa **kolumna zawiera** wszystkie **pliki** w nim zawarte. Stuknij dwukrotnie nazwę folderu, aby go otworzyć, przechodząc w dół ścieżki katalogu. Stuknij w **[biały pasek]** pod przyciskami **[SD]** i **[USB]**, aby przejść w górę ścieżki o jeden za każdym dotknięciem. **Panel pośrodku** zawiera opcje **filtrowania** i **funkcje sortowania**. Zaznacz pola zgodnie z potrzebami, aby wyświetlić zawartość w preferowany sposób.

13.2.1.2 OTWIERANIE PLIKÓW PDF

In **Czytnik PDF (PDF Reader)**, proceed as follows:

1. Stuknij pole **[Folder]** w lewym górnym rogu, aby otworzyć opcję Wybierz plik.



2. Określ nośnik pamięci, dotykając raz **[USB]** lub **[SD]**.



3. Nawiguj do preferowanego pliku.
 - a. Kliknij dwukrotnie nazwy folderów, aby je otworzyć (lewa kolumna).
 - b. Przejdź w górę ścieżki, dotykając **[biały pasek]** (lewa kolumna).



4. Wybierz plik, który chcesz otworzyć, klikając dwukrotnie pozycje listy w prawej kolumnie.

13.2.2 BOOKMARKS AND THUMBNAILS

Extensive documents with many pages like this manual are hard to navigate through without any anchor points to relate to. But we wanted to prepare the information of this manual in a way that it is easily accessible inside the console, so that users can quickly jump to those sections where they need help.

If a document contains bookmarks, then they are displayed in the left half of the resizable window next to the open page. Bookmark hierarchies can be opened and collapsed by tapping on the preceding arrow buttons.



Tap in the center of the dividing bar between both split windows and **resize the bookmark bar** as desired by dragging. Tapping on a bookmark name, will directly jump to the top of the page, where the section starts. Possibly, you must scroll down if the title is at the bottom of the page.

Inside the navigation bar on the right-hand side you can see a **[thumbnail]** of the open page. Tap on the thumbnail to open the **Page Select** browser. Tapping once on a thumbnail in Page Select will open the selected page directly without working your way through the bookmark hierarchy. Page

select is the quicker method for opening certain pages directly, if the page contains clearly distinguishable images or drawings.

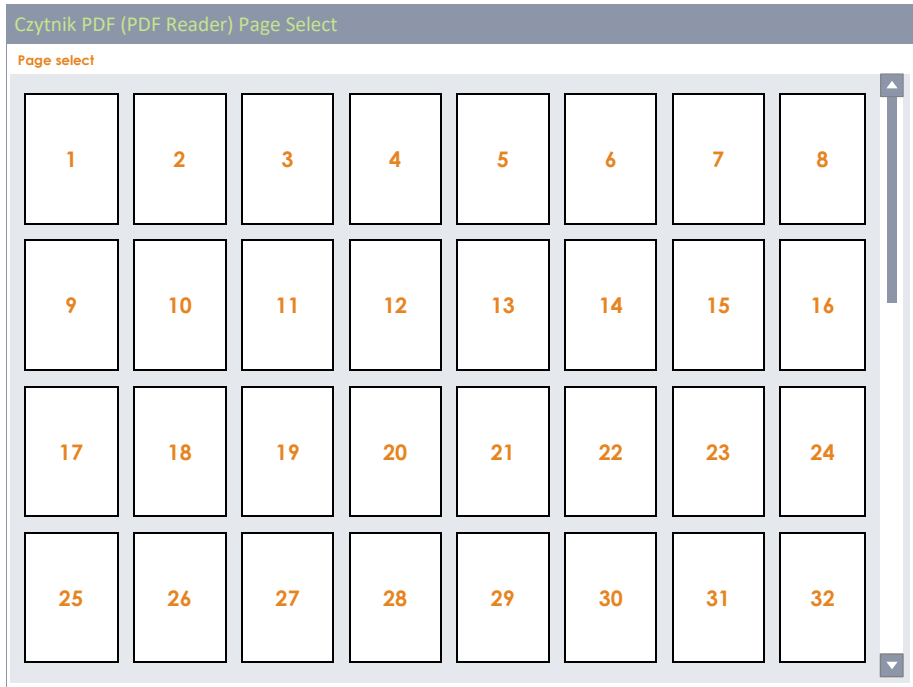

13.3 MENEDŻER PLIKÓW (FILE MANAGER)



The built-in file manager is an application to transfer data between an external USB device and the internal SD card. It can be used to manage your files as you would do on a regular PC or Mac. Move, copy, delete and rename files and folders of both sources (internal SD card and external USB device). There is no limit for file extensions, but keep in mind that the G9 may not provide applications to open them. However, it is possible to comfortably manage all storage mediums and file types without any external operating system. Icons are provided for the most common file extensions to easily distinguish between them when browsing folders. The ability to store your own files in the G9 makes a USB dongle obsolete. You can access your files wherever you go without carrying any other storage medium.



On Stage



PDF Reader



Import Tool



Shop



Menedżer plików



Narzędzi

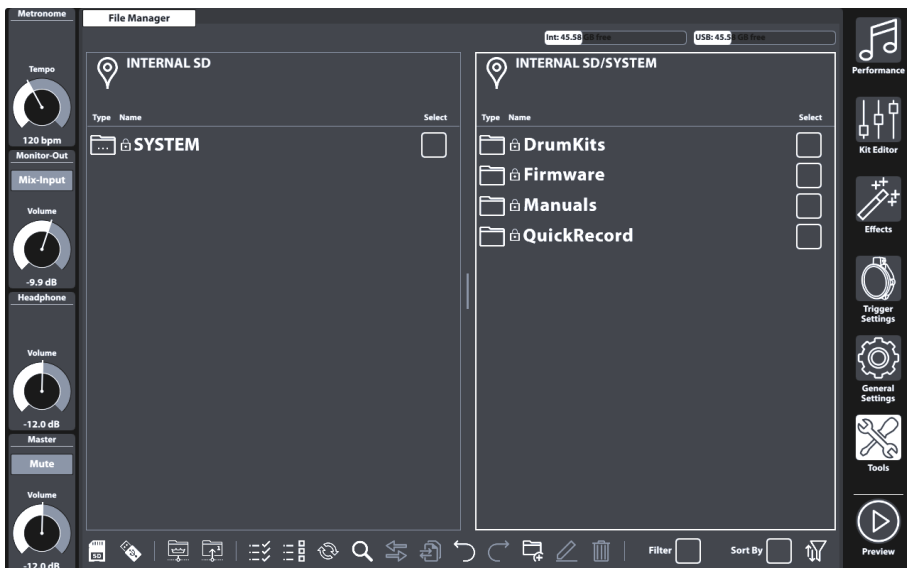

13.3.1 MENEDŻER PLIKÓW VS. IMPORTOWANIE PRÓBEK DŹWIĘKU

The **Narzędzia do importowania (Import Tool)** is designed to add samples to the **Sound Library** of the G9. It does not transfer data onto the internal SD card, but takes sound files from any source and encrypts the sample file into the G9’s native library format. Samples are encrypted and filed under the matching instrument category in the library. Consequently, samples are finally stored on the built-in **Flash Memory** for fast access and minimal load time. Files transferred via the **Menedżer plików (File Manager)** are stored on the internal **SD Card**.

In conclusion, **Narzędzia do importowania (Import Tool)** and **Menedżer plików (File Manager)** address different storage mediums and applications.

13.3.2 SCREEN LAYOUT AND GENERAL PROPERTIES

The File Manager is in the **Tools** mode (**Tools → File Manager**). Once you open it, a split window becomes visible. The top section informs about the current memory usage of all accessible storage mediums. Two horizontally resizable split windows allow for opening two different folders from either USB or internal SD Card. The header of each split window displays the path of the opened directory. Check boxes allow for selecting list entries and the task bar at the bottom provides tool for navigation, selection and filtering of folder contents.

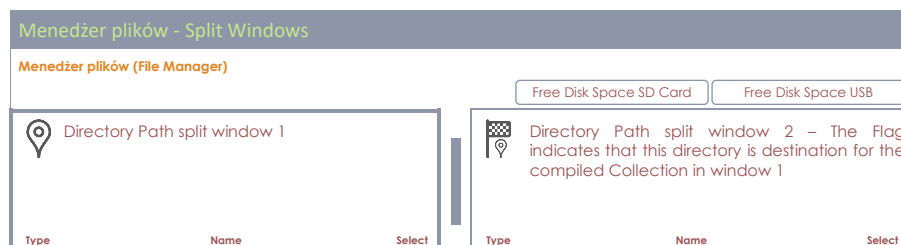

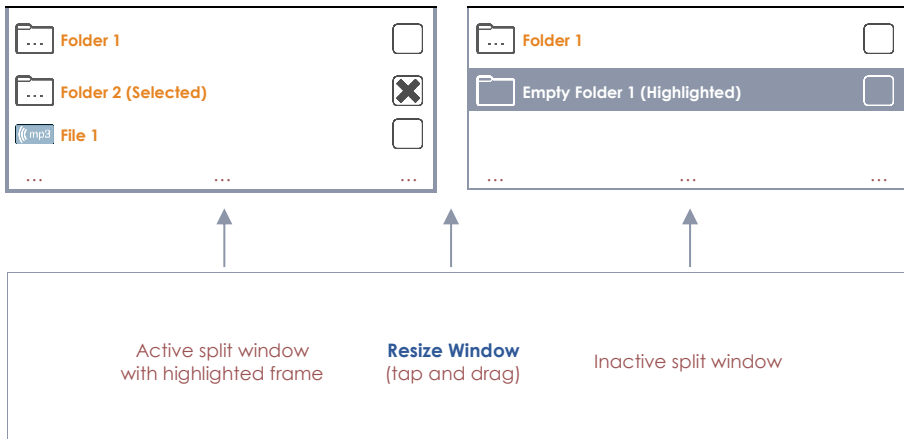

13.3.3 TASK BAR



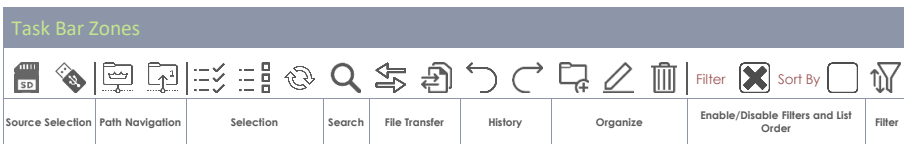













The task bar hosts all tools to organize your files. Apart from filters and sorting properties, which apply to both split windows, all functions (buttons) will take effect in the active split window above. The active split window is characterized by a highlighted frame. To change the active window, simply tap inside its frame and let the task bar functions affect the split window of your choice.



- with icons for navigation and actions
 - Selection of drives
 - Navigation via icons for path nodes (Root Directory, Folder level Up)
 - Search function (active directory and below)
 - Filter Manager for filters and ordering.
 - Selection functions for transfer of collections (Transfer Job)
 - Differentiation between highlighting and selecting
 - Undo and Redo function (tracking the last 10 steps)
 - Create new folders: always possible in the active split window, regardless whether there are existing collections
 - Rename Files/Folders (only one list entry at the same time)
 - Delete Files (batch processing)
 - Transfer buttons (Move/Copy) to start the transfer Job.

The following table explains the icons of the Task Bar:



	Internal SD card (opens root directory)
	External USB device (opens root directory)
	Go to root directory of the active path in active split window
	Move up one level in the folder hierarchy
	Check All
	Uncheck All
	Refresh (empties the collection of the active split window)
	Search
	Transfer: Move selected to defined destination
	Transfer: Copy selected to defined destination
	Undo (up to 10 steps)
	Redo (up to 10 steps)
	New folder (preserving existing collections)
	Rename highlighted list entry (preserving existing collections)
	Delete selected
	Opens the Filter Manager

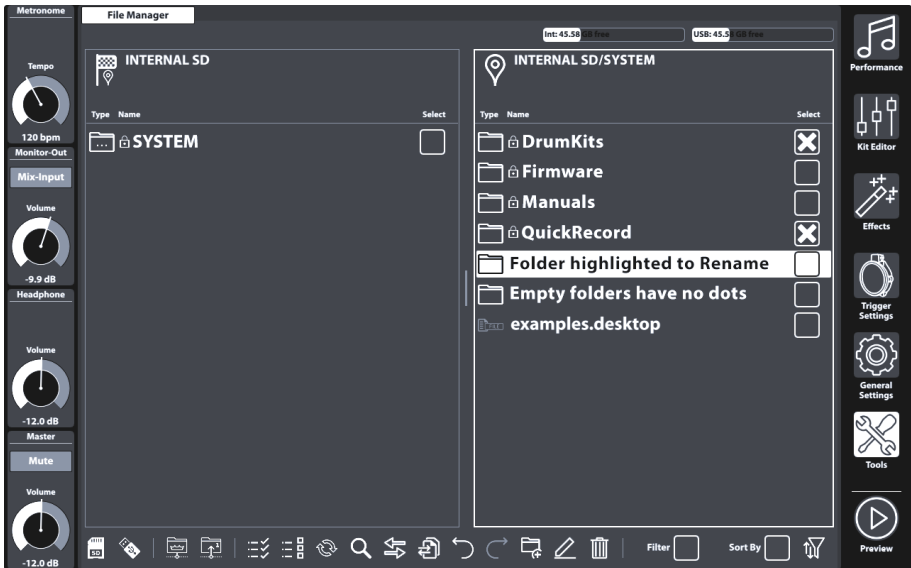

13.3.4 COLLECTIONS – CONCEPT AND OVERVIEW

Compiling a collection is the process of gathering several files and folders from multiple path directories of multiple sources (SD, USB) **within the same split window**. During this process, the G9 remembers the path directories of all selected items in the background, allowing to navigate seamlessly between sources and their folder hierarchies and without losing track of the files and folders selected. The built-in search function can be utilized at any time as an alternative to the linear navigation methods. A collection is opened when selecting the first list entry in a split window by tapping one of the **check boxes** in the **Select** column.



The definition of a **collection** extends the understanding of file management in ordinary file browsers and distinguishes itself from the term **selection**. While traditional file managers discard file selections as soon as you leave a folder to open a different directory, the G9 file manager remembers these selections, allowing to add more files from other directories. Thus, **a collection consists of selections spread out on different directories and storage mediums. In other Words: with collections you can treat different storage mediums as if they were different folders of the same drive.** Collections and selections are identical as long as you stay inside the same directory while selecting files. This means also, that you can approach the G9 file manager as any ordinary file manager without noticing any difference. The benefit of collections comes into play, when selecting many files from many directories: As opposed to the traditional way of copying files step by step before leaving a folder, the collection feature saves all intermediate steps and requires executing **job tasks** only once. Since the G9 file manager provides two split windows, the user can compile **maximally two parallel collections for maximally 2 different destination folders.**

Finally, when having compiled your collections you can apply a collection-based **job task** which will affect the collection of the active split window. The following collection-based job tasks are available:

Collection Based Tasks (Batch Processing)	
	Move
	Copy
	Delete

Tapping a task button will execute the chosen task for the **active split window**, preserving existing collections of the opposite split window. Other existing collections of the opposite window can be executed afterwards, allowing to choose a different job task if desired. There is no undo or redo possible once a job task button is tapped. However, in case of **Delete**, a warning message will appear and ask for confirmation to proceed, giving you the possibility to change your mind and

cancel the operation. Tapping the **[Refresh]** button will delete the collection of the active split window.

13.3.5 COMPILING COLLECTIONS

Proceed as follows:

1. Tap inside a split window to activate it as starting point.
2. Navigate to the directory with the relevant files using one or more of the following Options:
 - a. Select a drive.
 - b. Use the path navigation buttons (Root Directory, One Level Up).
 - c. Use the Search function
3. Once in the correct directory, start selecting one or more folders or files by tapping the **Check Boxes**.
4. Observe that the **Location Icon** in the opposite split window changes to the **Destination Icon**. As soon as you start a collection by checking the first item, the active directory of the opposite split window is set as destination by default. You can change this any time by navigating to a different directory and tapping the **Location Icon**. Consequently, the **Location Icon** changes to the **Destination Icon**.
5. Continue gathering folders and files by repeating steps 1-3.
6. Compile a second collection (optional) by activating the opposite split window (tap the area of folder contents) and proceed in the same fashion as described in steps 1-5. Note, that selected files of collection 1 appear grayed out. A file or folder can't be member of 2 collections at the same time. Navigate back in collection 1 and uncheck the item first before adding it to collection 2 and vice versa.
7. Activate a split window with an active collection, check the correct destination in the opposite window and tap the button for the chosen task.
8. (Optional) Repeat step 7 for existing collections of the opposite split window.

13.3.6 SELECTION RULES AND METHODS

The design of the gathering process requires unique rules of selection to avoid logical conflicts.

13.3.6.1 PARENTING

The G9 file manager uses the concept of **parenting**, which applies to selecting folders of a hierarchy. When checking a folder (Parent), all contained files and folders (Children) are checked likewise. If you check a parent and open the folder afterwards to uncheck files and folders to be excluded from the collection, the parent will remain checked. All its children stay checked, except for those who were unchecked manually. To facilitate this process the **[Check All]** and **[Uncheck All]** buttons are available. Both buttons follow the concept of parenting as well.

13.3.6.2 MEMBERSHIP OF A COLLECTION

Within the concept of collections, **no file or folder can be member of more than one collection**. Without this rule, a file in collection 1 could be moved to a different destination in first place. If it was member of collection 2 as well, the job protocol would address a dead path by the time of processing the job task of collection 2.

To avoid this conflict, the File Manager does not allow for double checking files and folders. Items checked in the left split window (Collection 1) will appear checked and grayed out in the right split window (Collection 2) and vice versa. Selections are only editable in the split window of the collection they are member of. Consequently, moving a file or folder to another collection requires unchecking it in Collection 1 first, to make available for Collection 2 (and vice versa).



13.3.6.3 REFRESH VS. UNCHECK ALL



The **[Uncheck All]** button affects all files and folders in the active directory and all files and folders in the **hierarchy below**, whereas **[Refresh]** unchecks **all members of the collection** of the active split window. With the search dialogue active **[Refresh]** only affects the search term. Deleting a collection is only possible in the default File Manager Screen.

13.3.7 COLLECTION BASED TASKS -MOVE/COPY/DELETE

With all collections compiled and destinations set, you can start the job task, by tapping one of the task buttons. Not every button behaves the same. The following list gives insight in the idea of each task:

Collection Based Tasks (Batch Processing)	
	Move
	Copy
	Delete

- **Move**
 - Collection based, affects all members of the collection in the active split window.
 - System calculates free disc space (SD, USB) before and after transfer, executes the job or returns an error message.
- **Copy**
 - Collection based, affects all members of the collection in the active split window.
 - System calculates free disc space (SD, USB) before and after transfer, executes the job or returns error message.
- **Delete**
 - Collection based, affects all members of the collection in the active split window.
 - Always asks for permission before executing the job.

Delete will trigger a warning message, allowing to change your mind and cancel the operation. **Undo** and **Redo** functions are NOT available in conjunction with **Move**, **Copy** and **Delete**.

13.3.8 ORGANIZE – NEW FOLDER AND RENAME

In the previous sections we discussed the concept of collections whose members are selected by using **check boxes** next to every list entry. Along with this concept we have presented three functions which can handle multiple selections at the same time, and which were consequently called "collection-based". These features are: Move, Copy and Delete.

There are more functions in the Task bar which work independently from existing collections: **Rename** and **New Folder**.

13.3.8.1 NEW FOLDER

New folders can always be added, even during the process of compiling collections for batch processing. Existing collections will remain intact when creating folders "on the fly".

Tapping the icon **[New Folder]** in the task bar will create a folder in the visible directory of the active split window. If necessary, please activate the split window of your choice beforehand by a single tap inside its frame.

Creating new folders:

1. (Optional) Select a split window by a single tap.
2. (Optional) Navigate to a directory of choice.
3. Tap **[New Folder]** in the Task Bar.
4. Enter a Name using the keyboard.
5. Confirm by tapping **[OK]** or abort by tapping **[Cancel]**.

13.3.8.2 RENAME

As with creating new folders, renaming of single list entries is always possible, without destroying existing collections. You can even rename already selected entries without losing collection memberships, if you perform the action in the window where they were selected.

As opposed to collection-based functions, renaming makes use of highlighting list entries. Tapping on a list entry outside the check boxes will highlight it by adding a thick bar in the background.

Note that the File Manager does not provide collection-based batch rename. This method would give every file and folder the same name followed by a number. After this procedure all information to identify a file would be lost. This feature only makes sense when dealing with photos, where you still have a thumbnail to identify the image. The G9 is a pro audio device and priorities in functionality are set accordingly.

Rename a file or folder as follows:

1. Highlight the File/Folder in the file list by a single tap. Avoid touching its check box.
2. Tap **[Rename]** in the Task Bar.
3. Enter a new name using the keyboard.
4. Confirm by tapping **[OK]** or abort by tapping **[Cancel]**.

13.3.9 HISTORY – UNDO AND REDO

The G9 File Manager features a 10-step history recording the following actions:

- a. Directory nodes visited across all storage mediums (SD, USB)
- b. Selections

This means that it tracks all actions across both split windows. Use the **[Undo]** and **[Redo]** buttons to move back and forth in history.



13.3.10 CLOSING THE APP

The File Manager closes by changing the mode or switching to one of the Apps inside the **Tools** modes. Existing Collections are retained until the G9 is shut down.

13.4 UTILITIES

The functions presented in this section find their application mainly in the Tools mode.

13.4.1 WYSZUKIWANIA (SEARCH)

 The search function of the G9 is viewed as a plug-in which is not exclusive of the File Manager. It can appear in other file browsers as well. It is designed as an inline tool which can be utilized as an alternative to linear path navigation (open folders by double tapping) and therefore inherits all important functions from the **File Manager Task Bar**.

13.4.1.1 PROPERTIES

- Keyboard at the bottom
- Search box
- Visible, active path (updates real time)
- Buttons for source selection (Internal, external)
- Buttons for navigation (Root Directory, One Level Up)
- Buttons for selections (Check All, Uncheck All – File Manager only)
- Refresh button to delete search term/string
- List of results with scroll bar for longer lists
- Check boxes for selection (File Manager)

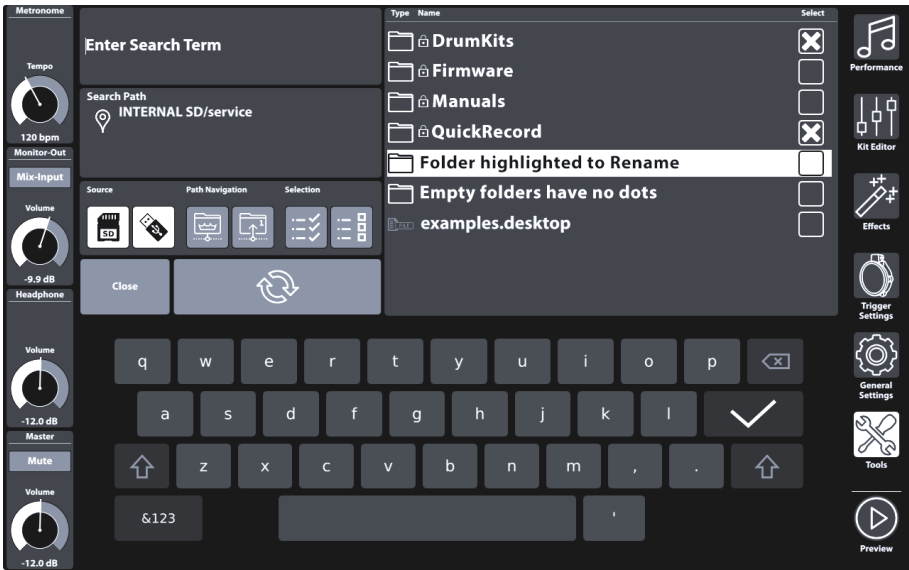

13.4.1.2 CONCEPTION

In File Manager, the search function serves as an In-line feature when compiling collections (*Zobacz sekcję 13.3.5 Compiling Collections na str. 142*). Meaning, that it can be utilized at any time and alternatively to linear folder navigation. Consequently, the search dialogue inherits all relevant icons of the task bar needed to serve this purpose. **Note, that in the search dialogue, the refresh button changes its function to clearing the search term only** (compiled collections remain intact)! Clearing collections can only be realized outside the search dialogue.

Search	
	Refresh (clears search term from the search box)
	Internal SD card (opens root directory)
	External USB device (opens root directory)
	Go to root directory of active path in active split window
	Move up one level in folder hierarchy
	Check All
	Uncheck All

- Opens by tapping the magnifying glass in the UI.
- Affects the active browser/split window only.
- Enter a search term via the keyboard.
- **Search rule:** "contains one or more words of the search term"
- Searches in the active folder and the hierarchy below.
- Lists files and folders.
- Navigation **up the path** (Buttons: Root Directory, one Level up)

- Navigate **down the path** by double tapping a folder.
- Double tapping does not select files/folders.
- Double tapping opens folder – Auto deletes search term (auto refresh) to view folder contents and edit selections caused by parenting.
- Double tapping files → no selection, just highlight
- List with results obeys filter and ordering settings.
- Selection via the check boxes
- Multiple selections possible
- "Check All" selects the complete result list only.
- "Uncheck All" only applies to list of results.

- **Menedżer plików (File Manager)**
 - List with results obeys filter and ordering settings made in the **Filter Manager**
 - Selections are added to collections of the active split window.

- **File Browsers (Song Player, Czytnik PDF (PDF Reader) etc.)**
 - No selection via check boxes – just regular browsing functionality
 - Independent from Filter Manager

- **Refreshing, editing the search term**
 - Selections made so far (Check Boxes) are added to the collection (File Manager) → continues collecting items for collections.

- **Close**
 - Tap "Close"
 - Or (Song Player/Czytnik PDF (PDF Reader)) → Double tap a file to select
 - Or change mode (e.g. to Performance)

- **Close Rules**
 - Selections made so far (Check Boxes) are added to the collection (File Manager).
 - Discards last search term.
 - Everything else: no effect (forgets having opened the search dialogue)

13.4.2 FILTER MANAGER



The Filter Manager is also viewed as a plug-In. It's application is primarily in conjunction with the Menedżer plików (File Manager). With longer lists of allowed file types, it is not possible to position all filters and ordering rules in the main screen. Consequently, sorting functions and filter types are organized in the filter manager menu. Filters and sorting rules can be activated or deactivated globally in the **Task Bar**.

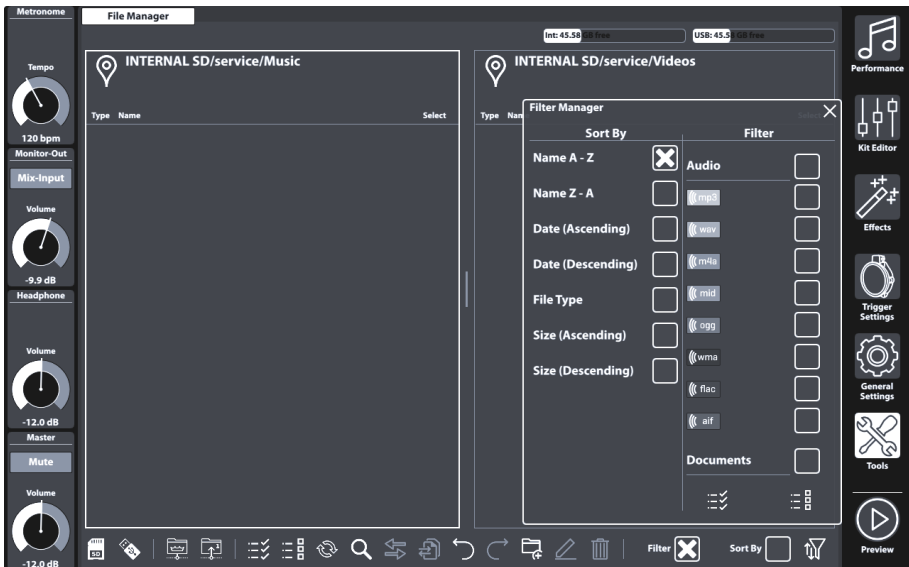









13.4.2.1 PROPERTIES























































Each file browser of the G9 provides filtering and ordering options which operate independently from each other. Consequently, the **Filter Manager** only affects browsers, where it is available.

- Opens by tapping the Filter Manager button
- Filters and ordering rules can be globally activated or deactivated in the task bar (Check Boxes)
- Columns with scroll bars
- Filter section categorized by file types
 - Multiple selections possible
 - Checking a category will select all file types of that category at the same time (parenting).
 - Uncheck individually if needed (category check box becomes unchecked, other children remain checked).
 - Check All/ Uncheck All buttons available (affect all categories and their file types at the same time)
- Sorting Function
 - No multiple selections allowed
 - Choose one of the options provided.
- Close
 - Close the dialogue by tapping the filter manager icon.
 - Change the mode (e.g. to Performance).
 - Tap a cross in the upper right corner of the manager.
 - Tap in any other area of the File Manager interface.
- Closing rules
 - Stores the last state of the Filter Manager (Selections) automatically.

13.4.2.2 FILTERS AND SORTING OPTIONS

The following table shows the complete list of sorting options and categorized Filters available. The G9 Filter Manager orders file categories by relevance to minimize the need of scrolling down the list during your daily work. Selections made in the Filter Manager will not affect **File Select** browsers (Song Player or Czytnik PDF (PDF Reader)), but only apply to the split windows of the **Menedżer plików (File Manager)**.

Filter Manager			
Sort By		Filter	
Name A-Z	<input checked="" type="checkbox"/>	Audio	<input type="checkbox"/>
Name Z-A	<input type="checkbox"/>	 mp3	<input checked="" type="checkbox"/>
Date (Ascending)	<input type="checkbox"/>	 wav	<input type="checkbox"/>
Date (Descending)	<input type="checkbox"/>	 m4a	<input checked="" type="checkbox"/>
File Type	<input type="checkbox"/>	 mid	<input type="checkbox"/>
Size (Ascending)	<input type="checkbox"/>	 ogg	<input type="checkbox"/>
Size (Descending)	<input type="checkbox"/>	 wma	<input type="checkbox"/>
		 flac	<input checked="" type="checkbox"/>
		 aif	<input type="checkbox"/>
		Documents	<input checked="" type="checkbox"/>
		 pdf	<input checked="" type="checkbox"/>
	
		⌵	⌵
		⌵	⌵
		⌵	⌵

Filter Manager – Complete Filter List								
Audio	Docs	Playlists	Video	Drum Kits	Device Specific	Music Notation	Graphics	Web
								
								
								
								
								
								
								
								
								
								
								
								
								

13.5 IMPORTOWANIE PRÓBEK DŹWIĘKU (IMPORT TOOL)



With the Narzędzia do importowania (Import Tool) it is possible to import files which are meant to be accessible in the sound library. Apart from the copy process, these files need to be encrypted into a G9 native format. If you just want to transfer files to the internal drive, please use the **Menedżer plików (File Manager)**. The Narzędzia do importowania (Import Tool) addresses the reserved partition for user samples on the built in 4 GB flash memory. The required file format for the import of custom sounds is **wave**. Only **single layer** Stereo files up to a maximum size of 32 MB can be imported, whereas the **Sklep (Shop)** offers a selection of **multi-layer** samples.



On Stage



PDF Reader



Import Tool



Shop



Menedżer plików



Narzędzi

13.5.1 IMPORTERZE (IMPORTER)

The Importerze (Importer) handles both ways of sound import. It lists all sounds in the order they were imported giving them a unique index number or import slot. The **Library** column lists all imported sounds. These sounds are available in the **Sound Browser**, filed under a specific instrument category and indexed according to the next free slot number available. The **Trash Can** icon deletes an entry from library and Importerze (Importer) likewise.

The **Storage** column lists all downloaded sound packages from the **Cloud**. Downloaded sounds are provided as **Sound Packages** with several containers which represent the different Instrument categories of the **Sound Browser**. It is not mandatory to import a complete drum kit or sound package. The storage column allows for importing individual containers only and gives an overview of which containers are imported from which sound package. Imported containers are highlighted (collapsed package view) or preceded by their import index (expanded view). Containers preceded by an arrow are downloaded, but still not imported.

The **Importerze (Importer)** serves as the management tool for all your imported sounds.

Importerze (Importer)		
Library		Storage
1	Imported Container B Sample Bow Sample Edge Sample Bell	Sound Package 1 (Collapsed) + Container A Container B (imported) Container C
101	Imported Custom WAV 1	Sound Package 2 (Expanded) - 2 Container 1 (imported) < Container 2 (not imported) < Container 3 (not imported)
2	Imported Container 1 Instrument 1 Instrument 2 Instrument 3	
102	Imported Custom WAV 2	

103 Imported Custom WAV 3 	
Memory Usage: 23% Status: 10%	<input type="button" value="Import wav samples"/>

13.5.2 IMPORT CUSTOM SAMPLES (SINGLE LAYER)



To import your custom samples, proceed as follows:

1. Go to **Tools** → **Import Tool**.
2. Tap **[Import wav samples]** to open the **File Select** browser.
3. Select a source (USB or internal SD card).
4. Browse to your directory with the desired samples.
5. Select a sample file by double tapping.
6. Observe the **Library** column until the import is completed (a **trash can** appears next to the imported file).
7. Go to **Kit Editor** → **Moduł 2** → **Sound Select** and assign imported sounds via the **Sound Browser**.



The File Select browser is explained in detail in **Performance** mode (*Zobacz sekcję 8.3.1.1 Przeglądarka plików (File Select Browser) na str. 26*).

G9 File Select Browser/Przeglądarka plików – Wybór nośników lub szukanie

 Intern
  USB
  Search

Navigation/Nawigacja – w górę ścieżki



G9 File Select Browser/Przeglądarka plików (WAV)

File Select ×

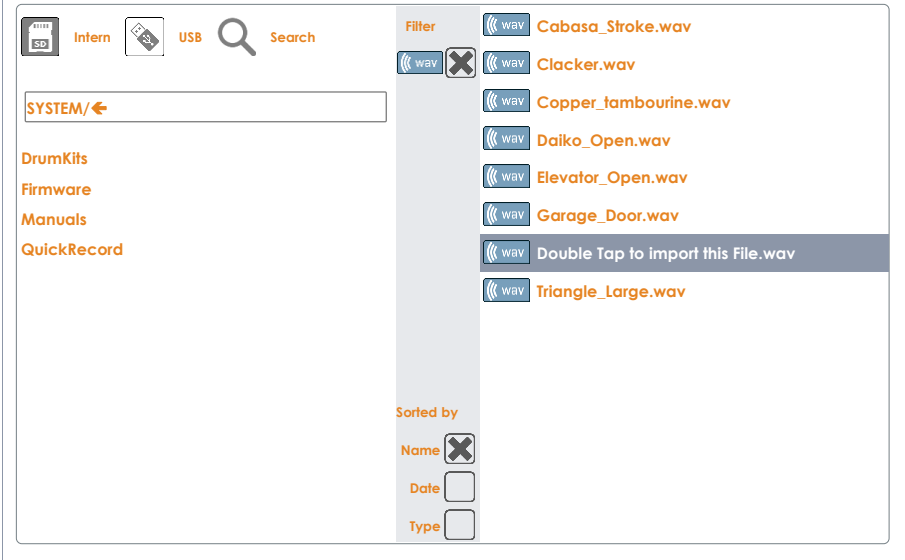

The **Sound Browser** is explained in detail in the **Kit Editor** section. Imported custom sounds are filed under category tab "Wave". Select **Import as Source** (*Zobacz sekcję 9.2.1.4 Sound Browser – Properties na str. 38*).

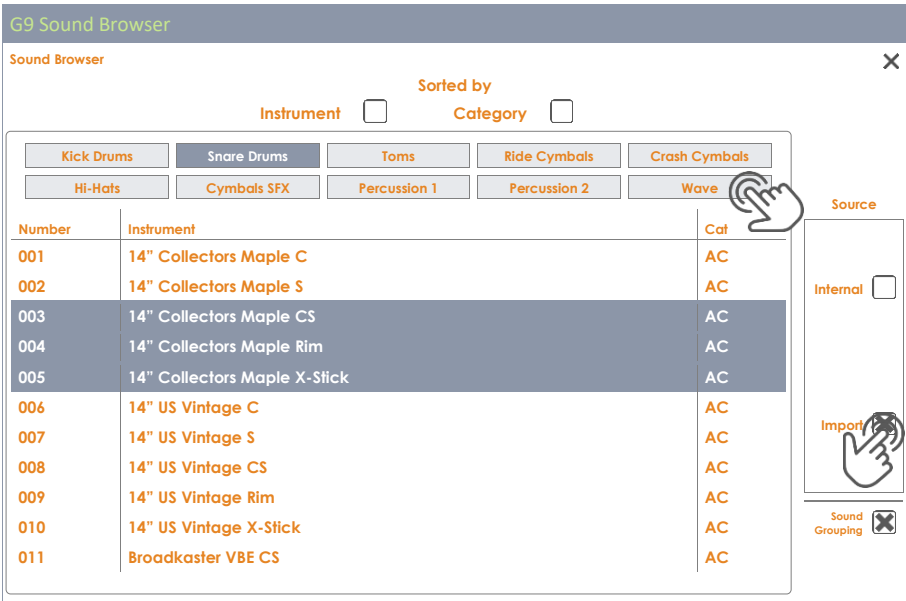

13.5.3 IMPORT SOUNDS FROM THE CLOUD

Sounds purchased in the Sound Store will appear in the **Storage** column after they have been downloaded to your local device using the G9 Sklep (Shop) application (*Zobacz sekcję 13.6.1 Connecting to the Cloud na str. 155*). The import process is identical with the import of custom sounds. However, sounds are downloaded and displayed as containers by instrument category in the storage tab. Complete drum kits require each container to be imported individually. This allows the user to extract individual instruments from a complete drum kit, cymbal set or instrument package.

To import a sound container, proceed as follows:

1. Expand the downloaded sound package by tapping the **[+]** button.
2. Tap once on the containers to be imported.
3. Observe the **Library** column until the import is completed (a **trash can** appears next to the imported file).
4. (Optional) Repeat steps 1 and 2 for other containers in the **Storage** tab.
5. Go to **Kit Editor** → **Moduł 2** → **Sound Select** and assign imported sounds via the **Sound Browser**.

The **Sound Browser** is explained in detail in the **Kit Editor** section. Imported custom sounds are automatically filed under the instrument categories associated with the imported containers. Select **Internal** as **Source** (*Zobacz sekcję 9.2.1.4 Sound Browser – Properties na str. 38*).

13.5.4 DELETE SOUNDS FROM THE LIBRARY

1. Go to **Tools** → **Import Tool**
2. Locate the sounds to be removed in the **Library** column.
3. Tap the **Trash Can** icon.

Deletion of imported Sounds removes the **Library** entry of the **Narzędzia do importowania (Import Tool)** as well as its entry in the **Sound Browser**.

13.5.5 LIMITY IMPORTU I ZARZĄDZANIE DŹWIĘKIEM

Zarówno import plików Wave, jak i import dźwięków ze Sklepu dotyczą wbudowanej pamięci flash 4 GB. W ten sposób masz szybki dostęp do swoich dźwięków podczas gry, co skutkuje szybkim czasem ładowania zestawów perkusyjnych za pomocą Selector Kit Selector lub narzędzia On Stage. Chociaż w większości przypadków dostępna przestrzeń dyskowa jest wystarczająca, tak zwani „zaawansowani użytkownicy” mogą doświadczyć zaimplementowanych ograniczeń, co spowoduje pytanie, jak poradzić sobie z tymi ograniczeniami. W tej sekcji znajdziesz wskazówki, jak efektywnie uporządkować dźwięki.

13.5.5.1 FAKTY

Wewnętrzna pamięć Flash o pojemności 4 GB jest podzielona na dwie części: w połowie znajduje się fabryczny bank dźwięku, którego użytkownik nie może modyfikować ani usuwać. Druga połowa (2 GB) jest dowolnie zarządzana.

Jeśli chodzi o limity, należy pamiętać o 2 typach: Maksymalna liczba miejsc do importowania i maksymalna dostępna pamięć do importowania dźwięku. Istnieją dodatkowe ograniczenia dotyczące właściwości formatu pliku WAV (*patrz sekcja 16 Dane techniczne na str 162*).

Import dźwięku - ograniczenia

Import Slots

Storage usage

100 Slots dla WAV import (101-200)
100 Slots dla Shop import (1-100)

2 GB pamięci flash dostępnej do importowania
przez użytkownika
(2 GB są zarezerwowane i zajmowane przez
fabryczny bank dźwięku)

13.5.5.2 SCENARIUSZE OGRANICZEŃ IMPORTU

Łatwo jest osiągnąć maksymalną liczbę miejsc importowania, importując wiele małych plików WAV. Z biegiem czasu import ten będzie się kumulował, a ponieważ są małe, istnieje duże prawdopodobieństwo, że w końcu osiągniesz limit do przesyłania 200, używając jedynie niewielką ilość pamięci flash.

Osiągnięcie maksymalnego rozmiaru pamięci wyłącznie przy użyciu importu WAV oznaczałoby, że konsekwentnie importujesz nagrania zbliżone do maksymalnego czasu nagrywania wynoszącego trzy minuty, co odpowiada rozmiarowi pliku około 32 MB. Zastosowanie takich próbek w kontekście perkusji jest bardzo rzadkie, więc jeśli chodzi o import WAV, najprawdopodobniej spotkasz się z **limitem maksymalnej liczby importowej**.

W przypadku dźwięków Sklep (Shop) sytuacja jest inna. Dźwięki te są wielowarstwowe, a zatem znacznie większe niż ich jednowarstwowe odpowiedniki WAV. W związku z tym dostępna przestrzeń pamięci odgrywa ważniejszą rolę. Zwłaszcza pakiety dźwiękowe Hi-Hat, których nie można podzielić na komponenty, muszą dodatkowo zawierać dźwięki dla różnych pozycji otwarcia kontrolera / pedatu. Obok wymiarów warstw prędkości MIDI i liczby różnych próbek na warstwę, dodawany jest inny wymiar. W związku z tym przy zwykłym pakiecie Hi-Hat o pojemności 300 MB użyjesz maksymalnie 7-10 miejsc do importowania, aż urządzenie zwróci komunikat ostrzegawczy dotyczący **maksymalnego wykorzystania pamięci**.

13.5.5.3 REAGOWANIE NA LIMITY IMPORTU

Odpowiedź jest prosta: Usuń nieużywane dźwięki z biblioteki dźwięków i nie bój się tego! Usunięcie dźwięku z biblioteki wygeneruje wolne miejsce w wewnętrznej pamięci flash. Dokonuje się tego poprzez stuknięcie ikony kosza w **importerze (Importer)** (*patrz sekcja 13.5.1 na str 150*). Mimo, że strona techniczna jest łatwa do rozwiązania, mogą pojawić się obawy związane z utratą danych i należy je rozwiązać. Poniżej przedstawiamy kilka wskazówek, które rozwieją wątpliwości.

13.5.5.4 UTRATA DANYCH

Usuwać dźwięki z biblioteki za pomocą **Narzędzia do importowania (Import Tool)**, wpisy są usuwane i usuwane z pamięci flash, ale nadal są dostępne do ponownego importowania na wewnętrzną kartę SD lub urządzeniu USB. Nabyte dźwięki ze Sklepu są pobierane na wewnętrzną kartę SD przed importem. Ta część karty SD jest ukryta i niedostępna za pomocą **Menedżera plików (File Manager)**. Pliki do pobrania ze Sklepu są wymienione w kolumnie **Pamięć (Storage)** importera, a ponadto są dostępne tylko w narzędziu do importowania. Po usunięciu z kolumny **Import** dźwięki w sklepie pozostają na liście w kolumnie **Pamięć (Storage)** są gotowe do ponownego importu - zaparkowane na karcie SD. Wyjątkiem jest **przywrócenie ustawień fabrycznych (Factory Reset)**. W przeciwieństwie do danych dostępnych za pomocą **Menedżera plików (File Manager)**, przywrócenie ustawień fabrycznych usunie pobrane pliki ze sklepu SD i opróżni kolumnę **Pamięć** importera. W takim przypadku musisz wykonać dodatkowy krok i ponownie pobrać dźwięki ze Sklepu. Realizacja praw własności do dźwięków wyklucza odkupywanie dźwięków usuniętych z urządzenia. Oznacza to, że są one zawsze dostępne do pobrania po zalogowaniu do aplikacji **Sklepu (Shop)** (*patrz sekcja 13.6.3 Digital Property Rights na str 158*).

Jeśli chodzi o import próbek WAV, zalecamy utworzenie folderu „importuj” na wewnętrznej karcie SD za pomocą **Menedżera plików** i skopiowanie dźwięków do urządzenia przed jakimkolwiek

importem. W ten sposób Twoje dźwięki są zawsze dostępne do importu. Takie pliki pozostają niezmienione przez **przywrócenie ustawień fabrycznych (Factory Reset)**.

13.6 SKLEP (SHOP)



The Sklep (Shop) tool provides direct access to the **GEWA Cloud**, where you can download additional sounds and samples purchased online in the **Sound Store**. Items purchased will be unblocked and from then on are listed for download in **Tools → Shop** and filed under the sample categories they belong to (Drumkit, Artist Kit, Percussion etc.).



On Stage



PDF Reader



Import Tool



Shop



Menedżer plików



Narzędzi

Before you can access the Sklep (Shop), you need to:

- a. Register your product online so that your G9 can decrypt the downloaded files.
[paste store/shop/cloud link here]
- b. Establish a Wi-Fi connection with an available network.

For information about the registration process please refer to [store website]. How to connect to your local network is explained in *sekcję 12.4.2 Wi-Fi na str. 119*.

Once registered and connected via Wi-Fi, you are ready to communicate with the Cloud.

Note that the G9 Sklep (Shop) application enables you to only download your purchased sounds. To make them available in your local sound library, sounds must be imported in a second step, utilizing the G9 **Narzędzia do importowania (Import Tool)** (Zobacz sekcję 13.5 Importowanie próbek dźwięku (Import Tool) na str. 149).

13.6.1 CONNECTING TO THE CLOUD

1. Go to **Tools → Shop** to open the Cloud browser.

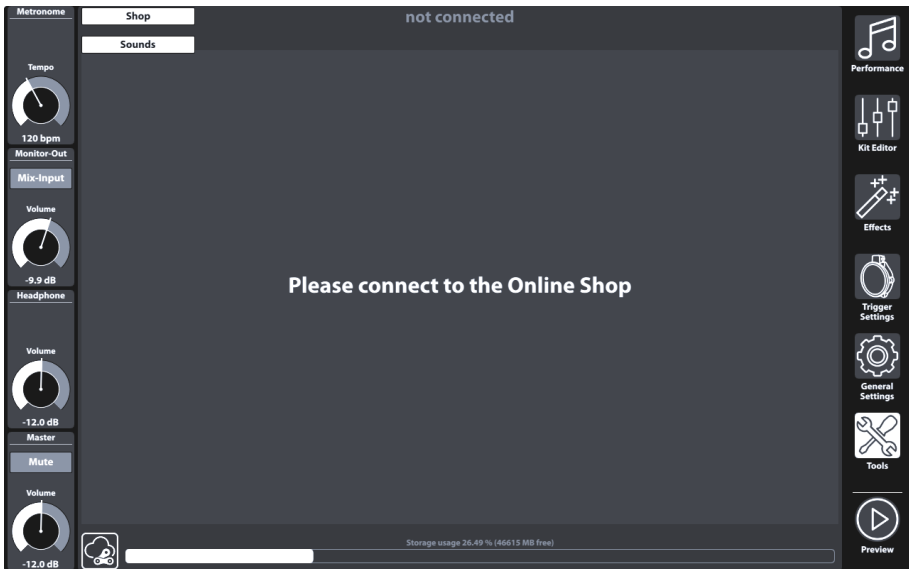

On start-up you are disconnected from the cloud by default and the landing page of the shop browser asks you to connect you G9 to the Cloud.

2. Tap on the **[Status]** button in the bottom left corner of the shop screen.

Icons - Cloud



Status button (Tap for connection details)

This will call up the **Login** pop-up. The dialogue contains information about your login data, such as **Serial Number** and the **Username** chosen during your registration. Highlighted in red you can observe the current status of your cloud connection, which should be **not connected**.

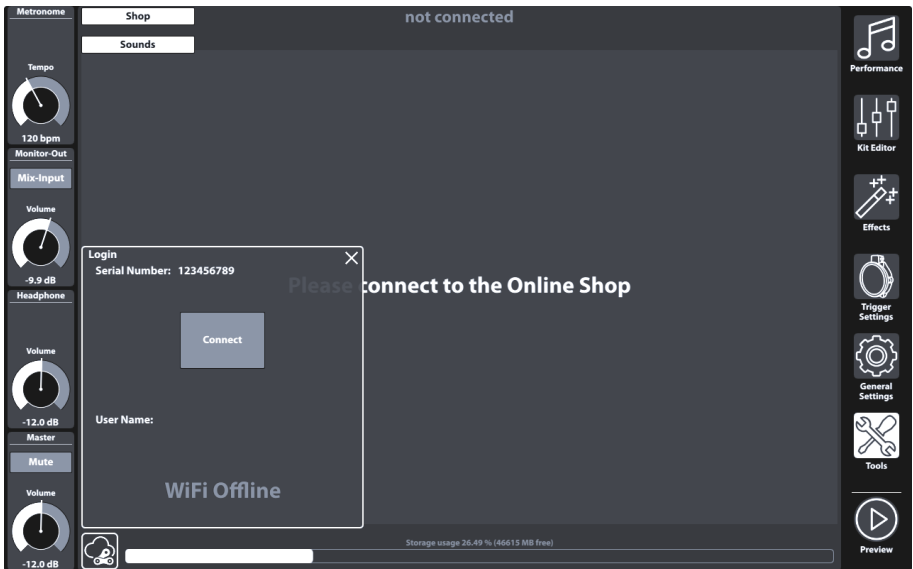

3. Tap **[Connect]** which should change the status to **"connected"** (highlighted in green).

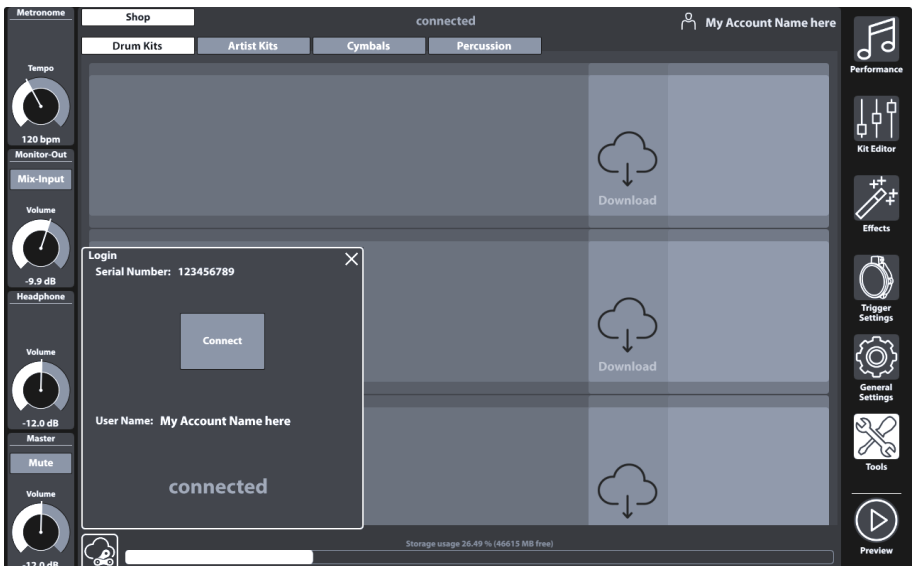

4. Close the Login dialogue by tapping **[X]**.

The Pop-up closes, and you should see your purchased items listed in the Sounds tab.

5. Browse the sounds sub tabs to view your purchased sounds by category.

6. Tap **[Download]** for sounds you want to import into the sound library and proceed with the import process. *(Zobacz sekcję 13.5 Importowanie próbek dźwięku (Import Tool) na str. 149).*

13.6.2 BILLING PROCESS

When browsing sounds online in the GEWA sound store you will find a **[buy]** button next to each item. Follow the wizard, choose your payment method and conclude your purchase. Confirmation email and invoice will be sent to the email address specified during the registration.

13.6.3 DIGITAL PROPERTY RIGHTS

With the purchase of a sound via the GEWA sound store the customer acquires a lifetime license, which entitles to download, and import purchased sounds for an infinite amount of times on up to 5 (five) G9 devices parallelly. The digital rights purchased apply to the number of registered device serial numbers in the sound store which are exchangeable.

13.6.4 SALE OR EXCHANGE OF A G9 DEVICE

Herewith, the customer is informed, that by selling a G9 device, existing digital rights will not expire and are still held by the seller. The buyer will have access to the sounds as long as the serial number of the sold device remains listed in the GEWA sound store account of the seller. It is the seller's responsibility to remove the serial number of the sold device from his GEWA sound store account before the sale. Without removal of serial numbers, buyers can use the sounds bought by the seller and are not able to conclude purchases themselves as long as the serial number of the bought apparatus is connected with the sellers account.

14 USEFUL INFORMATION

14.1 EXPLANATION OF TERMS

Term	Definition
MIDI	<p>Musical Instrument Digital Interface is a data transfer protocol. With this, musical control information is transferred between electronic instruments such as digital pianos, keyboards, synthesizers, drum computers or even PCs or laptops. To exchange this control information, the instruments/computers require MIDI connections and a link must be established between them. There are different MIDI connections with various functions: MIDI-IN (input), MIDI-OUT (output) and MIDI-THRU. The last one routes received data untouched from MIDI to be used for other MIDI device.</p> <p>Here is an example: If a key on the digital piano is pressed, digital data packets are sent from MIDI IN to MIDI OUT (MIDI-OUT). The data packets contain information on pitch, keyboard dynamic and the duration of the keystroke. The data packets output can be e.g. recorded, stored, played back on the computer and also displayed as notation on the screen if the application is able to do this. Recorded MIDI data can then be sent to a MIDI instrument, e.g. a digital piano, to make it audible again.</p>
GM	<p>General MIDI defines a lot more than what is defined in the basic MIDI protocol. It combines hardware and protocol specifications. General MIDI also specifies content. For this, GM sets a minimum standard for the assignment of the instruments to 128 program places. According to GM, a compatible GM MIDI instrument must be able to generate 24 sounds simultaneously. Furthermore, according to GM, additional control parameters are defined, such as e.g. effect control.</p>
General MIDI standard sounds	<p>Sounds or instruments in compliance with the specifications of the General MIDI standard protocol.</p>
Reverb	<p>This simulates a room environment. It is preconfigured for some sounds to give them a more lively and realistic appeal.</p>
Chorus	<p>The chorus effect adds another slightly detuned note to every note that is played. This produces a fuller ensemble like impression.</p>
Samples	<p>Samples are audio clip recordings from natural instruments. All sounds of sampled instruments are recorded and saved to logically defined locations. This then leads to an organized sum of sampled single notes, which, when played back, sound like the originally sampled natural instrument.</p>
DSP	<p>A digital signal processor (DSP) is a chip which is responsible for a continuous processing of digital signals such as audio and video signals.</p>
Polyphony	<p>Maximum number of simultaneously playable notes. A high number of simultaneously playable notes ensure a highly natural sound impression.</p>
Piezo	<p>Short term for piezo ceramic element (aka Buzzer). When deforming a piezo, a low electric voltage is generated, which depends on the degree of deformation. These sensors are used to detect the "velocity" or impact of a stroke in electronic drums and cymbals.</p>
FSR	<p>Force Sensitive Resistor are sensors used in cymbals to detect Choke, Crash (Edge) and Bell Signals. Unlike a piezo ceramic element, which produces electrical voltage when being deformed, FSR films always carry a low voltage which is decreases by applying pressure to the film (decreasing resistance).</p>

14.2 GWARANCJA

Gwarancja przyznawana jest na okres 2 lat od daty zakupu sprzętu i u autoryzowanego dealera, w którym pierwotnie zakupiono cyfrowy zestaw perkusyjny lub konsolę/moduł. W przypadku wady kupujący ma w pierwszym rzędzie prawo do świadczenia dodatkowego. Dodatkowe świadczenia obejmują naprawę lub dostawę produktu zastępczego. Sprzęt lub części wymieniane stają się własnością dealera zajmującego się reklamacją.

W przypadku, gdy naprawa nie powiedzie się, kupujący może zażądać obniżenia ceny zakupu lub odstąpić od umowy, a jeśli dealer odpowiada za powstałe wady, zażądać odszkodowania za szkody i / lub wydatki wynikające z reklamacji. Kupujący musi natychmiast poinformować sprzedawcę o wszelkich zidentyfikowanych wadach. Jedynym sposobem udowodnienia roszczenia gwarancyjnego jest to, że kupujący może przedstawić ważny dowód zakupu, np. faktura.

Uszkodzenia wynikające z niewłaściwego obchodzenia się, obsługi lub przechowywania, a także siły wyższej lub innych czynników zewnętrznych, nie są objęte warunkami gwarancji, a ponadto nie podlegają również produkty konsumenckie, takich jak np. akumulatory, sznurki, skóry lub uszczelki. Jeśli podejrzewasz, że masz roszczenie objęte warunkami gwarancji na produkt GEWA, skontaktuj się ze sprzedawcą.

15 PROBLEMY I MOŻLIWE ICH ROZWIĄZANIA

Problem	Możliwe rozwiązanie	
Konsola nie uruchamia się po naciśnięciu przycisku zasilania.	1	Upewnij się, że przewód zasilający jest prawidłowo podłączony do gniazdka elektrycznego i urządzenia. Instalacje na żywo spowodują włączenie przycisku zasilania. (stand-by → czerwony, być włączonym → biały)
Interfejs użytkownika zawieszają się (brak reakcji na gesty palca).	1	Wykonaj twardy reset, przytrzymując przycisk zasilania, aż urządzenie wyłączy się. Spróbuj ponownie uruchomić, naciskając ponownie przycisk zasilania. (Jeśli dzieje się to w suchym środowisku i przy braku jakichkolwiek ekstremów klimatycznych, skontaktuj się z obsługą klienta.)
Słyszę tylko jeden komponent/trigger (np. Główną lub obręcz)	1	Upewnij się, że podkładka i konsola oraz kable stereo są całkowicie podłączone. Jeśli chodzi o talerze i moduły GEWA, kabel stereo należy podłączyć do gniazda skierowanego w stronę piezoelektrycznego talerza.
Nie słyszę żadnego dźwięku (ani zestawu perkusyjnego, ani żadnych innych dźwięków, takich jak odtwarzanie utworów lub metronomu).	1	Sprawdź, czy słuchawki lub głośniki są prawidłowo podłączone do konsoli.
	2	Upewnij się, że wyjściowe pokrętki głośności nie są wyciszone (Słuchawki, Master, Mix Mix).
	3	Sprawdź ustawienia w macierzy routingu i załaduj „Domyślne ustawienia wstępne „Default Presets”. General Settings → Moduł 1 → Routing Drums + Routing others
Nie słyszę żadnego dźwięku z podłączonych padów, ale monitory triggerów reagują na uderzenia. Odtwarzacz piosenek i metronom są również słyszalne.	1	Sprawdź ustawienia w macierzy routingu i załaduj jedną z „ustawień fabrycznych” General Settings → Moduł 1 → Routing Drums + Routing others
	2	Jeśli ostatnio pracowałeś z MIDI , wyłączone jest sterowanie lokalne/ Local Control , to może uniemożliwić dostęp danych sterujących przez podłączony sprzęt do wewnętrznego modułu brzmieniowego. Sprawdź General Settings → Moduł 3 → MIDI → Global MIDI Settings (Soft Thru) → Local Control
Głośność wejścia miksowania lub wyjścia monitora nie jest regulowana.	1	Domyślnie regulacja jest ustawiona na Monitor-Out. Stuknij szary przycisk pod nazwą wybierania, aby przetestować się między wejściem monitora i wejściem miks i spróbuj ponownie. (Panel wybierania jest po lewej stronie ekranu dotykowego)
Nie słyszę żadnego dźwięku metronomu, ale słyszę zestaw perkusyjny i odtwarzacz piosenek.	1	Metronom może być wyciszony w trybie wizualnym. sprawdź Performance → Moduł 4 (Metronome) → Visual Mode
	2	Metronom nie jest kierowany do wyjścia, którego słuchasz. Sprawdź General Settings → Moduł 1 → Routing Others
Ikony komponentów w edytorze zestawu nie pasują do podłączonego typu padów.	1	Przypisz pasujący bank triggerów do danego kanału wejściowego i zapisz nową konfigurację triggera. Ikony wyświetlane w edytorze zestawu są sterowane przez bank triggerów przypisany do kanału wejściowego. (Triggers Settings → Moduł 1 + 2)
Mam zaimportowane brzmienia za pomocą narzędzia do importowania, ale nie mogę ich znaleźć w przeglądarce dźwięku (Edytor zestawu).	1	Otwórz przeglądarkę brzmień i zaznacz „Importuj” po prawej stronie okna przeglądarki. Spowoduje to wyświetlenie tylko importowanych brzmień. Podobnie jak dźwięki fabryczne, importowane dźwięki są zapisywane w odpowiedniej kategorii instrumentów.

16 DANE TECHNICZNE

G9 Drum Workstation – Specyfikacja techniczna	
Drum-Kits / zestawy	40 Preset + nieograniczony User Presets
Instruments / Instrumenty	ponad 400
Effect Types / rodzaje efektów	Pad Compressor: 3-zakresowy parametryczny EQ na każdy Pad Output Compressor & 4 zakresowy parametryczny EQ na każde z wyjść Output Room: 12 rodzajów / Multi: 9 Algorytmów
User Sample Import / Import własnych próbek	100 Wave / 100 Multi layered full instruments [Naciąg/Obręcze/X-Stick (Head/Rim/X-Stick) - Kopałka/Łuk/Krawędź (Bell/Bow/Edge)] File Format/Format plików: WAV (Tylko format PCM) (44.1KHz/48KHz, 16/24/32 bit, do 8M próbek na kanał [≈3 min Stereo]) Kanałów mono lub stereo
Storage / Pamięć	USB/internal Memory (pamięć wewnętrzna)
Recorder / Rejestracja	Realtime (wav) File Format/ Format plików: WAV (44.1 kHz, 16 bit)
Display / Wyświetlacz	1280 x 800px TFT zintegrowany z ekranem dotykowym 4 fizyczne regulatory połączone z Software
External Memory / Zewnętrzna pamięć	external USB/zewnętrzne USB
Connections / Połączenia	TRIGGER INPUTS/WEJŚCIA: 14 x ¼" TRS Socket MONITOR OUT/WYJŚCIA: 2 x ¼" TS Socket (Mono) MASTER OUT/WYJŚCIE: BALANCED XLR SPDIF (Stereo) 48 kHz DIRECT OUT/WYJŚCIE: 8 x ¼" TS Socket (Mono) PHONES/SŁUCHAWKI: ¼" TRS Socket (Stereo) MIX IN/WEJŚCIE: ¼" TRS Socket (Stereo) MIDI (IN, OUT,THRU)-Outputs COMPUTER-CONNECTION/POŁĄCZENIE: USB B-Type (USB Hi-Speed AUDIO/MIDI) FOOT SWITCH/PRZEŁĄCZNIK NOŻNY: 1 x ¼" TRS (2 Channel) AC IN/WEJŚCIE NA ZASILACZ (IEC C17)
Wireless Connections / Pol.Bezprzewodowe	Bluetooth, Wi-Fi
Recording / Nagrywanie	Sampling Rate (Original): 48 kHz Sampling Rate: (Z Converterem): 96 kHz, 44,1 kHz Recording: 8 Channels/Kanałów Play: 2 Channels/Kanały
Power Supply / Zasilanie	AC 100V-240V 50Hz - 60Hz
Electricity Consumption / Pobór mocy	10 W (IEC 62087), 55 W (EN60065)
Dimensions / Wymiary	340 (W) x 215 (D) x 91 (H)
Weight / Waga	3,3 kg
Accessories Included / Zawarte akcesoria	Szybki start instrukcja z przepisami bezpieczeństwa (wielojęzyczny, drukowany) Klucz sprzętowy USB z wielojęzycznym podręcznikiem szybkiego startu. 5 Kabel zasilający (Typ A, Typ C (CEE 7/16 + CEE 7/17), Typ F, Typ I)
* Wszystkie specyfikacje i wygląd mogą ulec zmianie bez powiadomienia	